



Penco Products, Inc.
www.pencoproducts.com

ILLUSTRATED PRICE BOOK

- *Clipper® Industrial Shelving*
- *Grating & Handrail*
- *Related Multi-Level Accessories*
- *Wide Span Shelving*
- *RivetRite® Shelving*
- *Pallet Rack*
- *Shop Furniture*
- *E-Z Bilt™ Storage Cabinets*



For Information or to Place an Order:
Call Toll Free: 800-562-1000
FAX: 800-248-1555

Effective May 19, 2014

Note: See our other price lists for *Lockers*,
Erectomatic® Shelving or *QuickShip products*.



General Instructions

All prices are based on Penco Standard Construction.

All orders are subject to final acceptance at the main office.

SPECIFICATIONS: (Subject to change without notice) Refer to current Penco Catalogs for description and specifications of Penco Products, Inc.

LEAD TIMES: See the Penco Web site for lead times (www.pencoproducts.com/lead-times).

Special Engineering or engineering drawings for approval require additional time and above specified deliveries do not apply. Such drawings can be supplied only on an order of \$10,000 total price book value or more. Shipment for this type of order normally requires 6 to 8 weeks after receipt of approved drawings. Nonstandard fillers and trim can be supplied only on orders for \$4000 price book value or more.

FREIGHT CHARGES: All shipments will be made pre-pay and add unless otherwise specified. When freight is prepaid, charges will be added to the invoice. Parcel post charges will be added to invoice. Each order must be for one destination to one consignee.

RETURN SHIPMENTS: No return shipments will be accepted without previous written factory authorization. A restocking charge of 25% or more with a minimum of \$50.00 net will be levied on all authorized material subject to inspection for damage at the factory. Special orders including welded lockers or factory assembled products are NOT eligible for return. No credit will be issued for damaged material. Material returned without authorization will be refused. All return freight charges must be prepaid.

HOW TO ORDER: Order by indicating quantity, catalog number and color. Do NOT use standard catalog numbers for special or modified parts. Lockers will be furnished with 6" legs unless otherwise specified.

COLORS: In some cases the 'traditional' colors are mentioned, however any of our 24 colors are available on most products. Color names are shown on the next page. The customer must specify color desired on all orders.

WEIGHT: Weights shown are approximate shipping weights for average packing per average order.

CHANGES & CANCELLATIONS: Orders changed after scheduling but before manufacturing are subject to a minimum \$100.00 net charge, if approved by the main office. Changes may have an adverse effect on scheduled ship date. Orders are not subject to changes or cancellations

after commencement of manufacturing. Orders requiring engineering drawings are subject to an engineering fee if cancelled.

CLAIMS AND FREIGHT DAMAGE: Claims for damaged or lost material must be filed with the carrier. Claims for shortages must be made in writing to the main office within 72 hours from receipt of shipment.

Caution: When you give the delivering carrier a clear receipt for a shipment in which there is damaged merchandise or a shortage, the carrier is relieved of further responsibility. Claims for damage or shortage must be filed by you with the delivering carrier. Penco will not accept return of merchandise damaged in transit. Your claim is with the delivering carrier.

CHOICE OF CARRIER: Penco retains the right to select the most appropriate carrier for delivery to your order's destination.

GUARANTEE: We guarantee our products for a one year limited warranty to be free from mechanical and manufacturing defects. Penco is not responsible for products damaged by misuse, abuse or any acts of vandalism. The guarantee is also voided if the finish is exposed to items such as high humidity, chlorine salts, abrasive cleaners, germicidal cleaners or acids.

SMALL ORDER POLICY: MINIMUM ORDER - \$50.00 Net plus shipping costs.

PACKAGING AND MARKING: For special crating, marking, palletizing, or export packing, contact your Penco Representative for availability and cost.

INSTALLATION: For installation at job site contact the local Penco Representative for assistance in locating installation personnel. Unless otherwise specified, all products are shipped knocked down (unassembled) from the factory.

QUICKSHIP PROGRAM: Certain products, shown in a separate price list, are available from multiple warehouse locations on a QuickShip basis, many available for shipment in 72 hours. Popular sizes of the following products are in the QuickShip program: Clipper & RivetRite Shelving, Lockers, locker accessories and Storage Cabinets. Bleachers and Team benches are also available on a QuickShip basis. For locations of QuickShip warehouses and which products are stocked there, please refer to our website at: www.pencoproducts.com/quickship.

PENCO ASSUMES NO RESPONSIBILITY FOR PRODUCT FAILURE OR PERSONAL INJURY IF PRODUCTS ARE MODIFIED OR USED FOR OTHER THAN THEIR DESIGNED PURPOSE.

Prices are F. O. B. plant of manufacture, knocked down and subject to change without notice. Penco Products reserves the right to determine plant of manufacture. Prices are in U.S. Dollars at time of shipment.

Penco Products, Inc. pursues a continuing program of design and products improvement. When such improvements occur, or when conditions exist beyond our control, Penco reserves the right to furnish equipment considered standard at the time of shipment.

Price Book Info / Freight Classes / Contents

Price Book Information

How to Read This Price List: Pricing Information is printed in two columns on most pages, flowing from the bottom of one column to the top of the next column. Do not read across columns; read it as you would read a newspaper.

Dimensions: Unless stated otherwise, all sizes are in inches.

Footnotes: The "NOTES" column is marked with a "*" at the top of the page. Refer to the bottom of each page for the key to the symbols found in the column.

Abbreviations: In the "Per" column, the following apply: "Ea." = Each; "Pr." = Pair; "Frm." = Frame; "Bdl." = Bundle; In the "Std. Pkg" column (Standard Packaging), "LPP" = Like Parts Packed Together; "PPO" = Packed Per Order.

Other Sizes: In most product lines, other sizes are available. Contact your Penco representative with your requirements.

Freight Classes

Freight Class

F.O.B. Hamilton, NC 27840

50	RivetRite Shelving, Pallet Rack Beams, Channel Lock Safety Grating, Handrail
60	Particle Board
70	Pallet Rack Frames
	<u>Shelving:</u>
	Clipper, , Wide Span, Erectomatic & Modular Drawers for Shelving
	<u>K.D. Lockers:</u>
	All KD Lockers
	K.D. Storage Cabinets, Steel Work Benches, Locker Room Benches, Basket Racks, Hardware.
85	Bench Pedestals, Shop Desks, Work Bench Drawers, Bleachers, Team Benches
125	Assembled Lockers (assembled from KD parts) Assembled Storage Cabinets and All-Welded Lockers

The factory shipping point is shown above for your convenience, however, Penco and its vendors reserve the right to change shipping points at any time without notice. "QuickShip" products (found in a different price list) shipping points can differ. See www.pencoproducts.com/quickship for more information on QuickShip products.

Color Selection

24 Standard Colors are available on most products. Color Chart is available.

012 Tawny Tan	073 Champagne	767 Cardinal Red
021 Gray Ash	701 Spray Green	806 Marine Blue
028 Gray	710 Sagebrush Yellow	812 Hunter Green
052 Reflex Blue	715 Lake Blue	822 Regal Blue
054 Canvas	720 Mandarin Orange	826 Slate Blue
055 Shamrock	722 Patriot Red	848 January White
056 Sunburst	723 Light Putty	949 Jet Black
058 Nordic Purple	736 Burgundy	952 Turquoise Teal

Contents

Clipper Shelving Open/Closed Units.....	4
Clipper Bin Units.....	5
Clipper Specialty Shelving and Components.....	6
Clipper Shelving Components.....	7-8
Clipper Hi-Performance Shelves.....	9
Clipper Shelving Accessories.....	10-11
Channel Locker Safety Grating.....	12
Handrail & Shelving Hardware.....	13
Wide Span Shelving Units and Tire Racks Units.....	14
Wide Span Components.....	15
Wide Span Beams, Supports and Braces.....	16
Wide Span Shelves and Side Shelf Supports.....	17
RivetRite Shelf Framing.....	18
RivetRite Double Rivet Shelving Units.....	19-20
RivetRite Single Rivet Shelving Units.....	21
RivetRite Record Storage Units.....	22
RivetRite Automotive Shelving Units.....	23
RivetRite Components Parts.....	24-28
RivetRite Particle Board.....	29
Pallet Rack Introduction.....	30
Pallet Rack Frames.....	31-35
Pallet Rack Beams.....	36-37
Pallet Rack Accessories.....	38-39
Shop Furniture	40-45
Open Work Benches Without Shelf & With Shelf.....	40-41
Modular Work Benches	41-42
Shop Desks & Work Bench Components.....	42
Work Bench Tops	43
Inventory Carts & Service Carts.....	44
Stools & Locks for Shop Furniture.....	45
Storage Cabinets	45-46
Touch-up Paint.....	46



Clipper Shelving Units

W D H * Cat. No. Price Per Wt. Pkg.

W D H * Cat. No. Price Per Wt. Pkg.

Open Basic Clipper Units consist of:
1 Front Box Post, 2 rear Offset Angle Posts,
Side & Back Sway Braces, Heavy Duty Hi-Performance Shelves.
Order Open Clipper End Kits in the appropriate depth separately.

Closed Basic Clipper Units consist of:
1 Front Box Post, 2 rear Offset Angle Posts,
Side and Back Panels, Heavy Duty Hi-Performance Shelves.
Order Closed Clipper End Kit in the appropriate depth separately.

Open Clipper Basic Units

Closed Clipper Basic Units

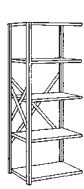

5 Shelves

Heavy Duty Hi-Performance

36	12	87	1H7015	217.20	Ea.	59.6	LPP
36	18	87	1H7025	250.70	Ea.	70.5	LPP
36	24	87	1H7035	282.85	Ea.	81.7	LPP
42	12	87	1H7045	236.75	Ea.	65.1	LPP
42	18	87	1H7055	270.50	Ea.	78.0	LPP
42	24	87	1H7065	309.65	Ea.	90.2	LPP
48	12	87	1H7075	260.25	Ea.	70.6	LPP
48	18	87	1H7085	327.50	Ea.	85.0	LPP
48	24	87	1H7095	379.40	Ea.	99.3	LPP

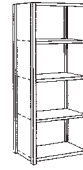

5 Shelves

Heavy Duty Hi-Performance

36	12	87	1H8015	306.20	Ea.	82.5	LPP
36	18	87	1H8025	350.20	Ea.	96.3	LPP
36	24	87	1H8035	392.25	Ea.	110.5	LPP
42	12	87	1H8045	347.35	Ea.	91.7	LPP
42	18	87	1H8055	391.60	Ea.	107.5	LPP
42	24	87	1H8065	440.65	Ea.	122.9	LPP
48	12	87	1H8075	389.70	Ea.	100.4	LPP
48	18	87	1H8085	467.45	Ea.	117.8	LPP
48	24	87	1H8095	529.25	Ea.	135.2	LPP

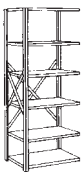

6 Shelves

36	12	87	1H7016	243.60	Ea.	66.6	LPP
36	18	87	1H7026	283.60	Ea.	79.5	LPP
36	24	87	1H7036	321.85	Ea.	92.9	LPP
42	12	87	1H7046	266.65	Ea.	73.2	LPP
42	18	87	1H7056	306.95	Ea.	88.5	LPP
42	24	87	1H7066	353.60	Ea.	103.1	LPP
48	12	87	1H7076	294.85	Ea.	79.6	LPP
48	18	87	1H7086	375.35	Ea.	96.8	LPP
48	24	87	1H7096	437.30	Ea.	113.9	LPP

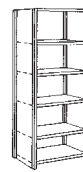

6 Shelves

36	12	87	1H8016	332.60	Ea.	89.5	LPP
36	18	87	1H8026	383.10	Ea.	105.4	LPP
36	24	87	1H8036	431.25	Ea.	121.7	LPP
42	12	87	1H8046	377.25	Ea.	99.7	LPP
42	18	87	1H8056	428.05	Ea.	118.0	LPP
42	24	87	1H8066	484.60	Ea.	135.8	LPP
48	12	87	1H8076	424.30	Ea.	109.5	LPP
48	18	87	1H8086	515.30	Ea.	129.7	LPP
48	24	87	1H8096	587.15	Ea.	149.9	LPP

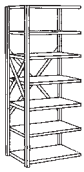

7 Shelves

36	12	87	1H7017	270.00	Ea.	73.6	LPP
36	18	87	1H7027	316.50	Ea.	88.6	LPP
36	24	87	1H7037	360.85	Ea.	104.1	LPP
42	12	87	1H7047	296.55	Ea.	81.2	LPP
42	18	87	1H7057	343.40	Ea.	99.0	LPP
42	24	87	1H7067	397.55	Ea.	116.0	LPP
48	12	87	1H7077	329.45	Ea.	88.7	LPP
48	18	87	1H7087	423.20	Ea.	108.7	LPP
48	24	87	1H7097	495.20	Ea.	128.5	LPP

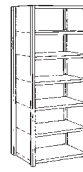

7 Shelves

36	12	87	1H8017	359.00	Ea.	96.5	LPP
36	18	87	1H8027	416.00	Ea.	114.4	LPP
36	24	87	1H8037	470.25	Ea.	133.0	LPP
42	12	87	1H8047	407.15	Ea.	107.7	LPP
42	18	87	1H8057	464.50	Ea.	128.5	LPP
42	24	87	1H8067	528.55	Ea.	148.6	LPP
48	12	87	1H8077	458.90	Ea.	118.6	LPP
48	18	87	1H8087	563.15	Ea.	141.5	LPP
48	24	87	1H8097	645.05	Ea.	164.5	LPP

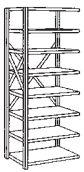

8 Shelves

36	12	87	1H7018	296.40	Ea.	80.6	LPP
36	18	87	1H7028	349.40	Ea.	97.6	LPP
36	24	87	1H7038	399.85	Ea.	115.4	LPP
42	12	87	1H7048	326.45	Ea.	89.2	LPP
42	18	87	1H7058	379.85	Ea.	109.5	LPP
42	24	87	1H7068	441.50	Ea.	128.9	LPP
48	12	87	1H7078	364.05	Ea.	97.7	LPP
48	18	87	1H7088	471.05	Ea.	120.5	LPP
48	24	87	1H7098	553.10	Ea.	143.2	LPP

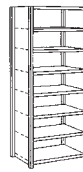

8 Shelves

36	12	87	1H8018	385.40	Ea.	103.5	LPP
36	18	87	1H8028	448.90	Ea.	123.5	LPP
36	24	87	1H8038	509.25	Ea.	144.2	LPP
42	12	87	1H8048	437.05	Ea.	115.8	LPP
42	18	87	1H8058	500.95	Ea.	139.1	LPP
42	24	87	1H8068	572.50	Ea.	161.5	LPP
48	12	87	1H8078	493.50	Ea.	127.6	LPP
48	18	87	1H8088	611.00	Ea.	153.4	LPP
48	24	87	1H8098	702.95	Ea.	179.1	LPP

Open Clipper End Kits

Closed Clipper End Kits



To End Row of Open Shelving

Consists of front Box Post and 1 pair of Side Sway Braces.

12	87	101287	38.85	Ea.	10.0	LPP
18	87	101887	39.85	Ea.	11.0	LPP
24	87	102487	41.50	Ea.	12.0	LPP



To End Row of Closed Shelving

Consists of front Box Post and Side Panel.

12	87	1C1287	55.80	Ea.	14.0	LPP
18	87	1C1887	67.30	Ea.	18.0	LPP
24	87	1C2487	78.85	Ea.	22.0	LPP

Front Bases for Closed Clipper Shelving units shown above must be ordered separately.

Clipper Bin Units (with Front Bases)



W D H * Cat. No. Price Per Wt. Pkg.

W D H * Cat. No. Price Per Wt. Pkg.

Closed Basic Clipper Bin Units consist of:
 1 Front Box Post, 2 rear Offset Angle Posts,
 Side and Back Panels, H.D. Hi-Performance Shelves, Dividers & Bin
 Fronts as required. **Order Closed Clipper End Kit in the
 appropriate depth separately. (Label Holders not included)**

Note: Bin widths are nominal. They are measured from the hole centers on the shelves, not the vertical bead of the dividers.

Clipper Bin Basic Units

9 Openings

Heavy Duty Hi-Performance
 8 - 36" x 9", 1 - 36" x 12"

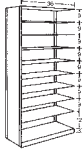

36	12	87	1H6109	446.70	Ea.	118.8	LPP
36	18	87	1H6209	523.20	Ea.	142.9	LPP
36	24	87	1H6309	595.75	Ea.	167.9	LPP

9 Openings

8 - 48" x 9", 1 - 48" x 12"

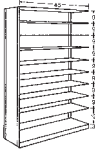

48	12	87	1H6409	573.05	Ea.	147.4	LPP
48	18	87	1H6509	717.05	Ea.	178.7	LPP
48	24	87	1H6609	829.10	Ea.	210.0	LPP

21 Openings

21 - 12" x 12"

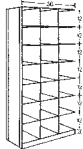

36	12	87	1H6121	524.80	Ea.	118.9	LPP
36	18	87	1H6221	601.60	Ea.	147.8	LPP
36	24	87	1H6321	696.95	Ea.	176.2	LPP

28 Openings

28 - 12" x 12"

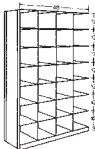

48	12	87	1H6428	700.20	Ea.	150.5	LPP
48	18	87	1H6528	837.65	Ea.	189.6	LPP
48	24	87	1H6628	982.10	Ea.	226.8	LPP

35 Openings

32 - 9" x 9", 3 - 12" x 12"

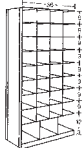

36	12	87	1H6135	663.40	Ea.	139.6	LPP
36	18	87	1H6235	762.20	Ea.	176.7	LPP
36	24	87	1H6335	893.75	Ea.	213.1	LPP

52 Openings

48 - 8" x 9", 4 - 12" x 12"

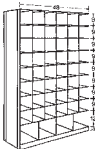

48	12	87	1H6452	931.10	Ea.	181.8	LPP
48	18	87	1H6552	1111.95	Ea.	206.0	LPP
48	24	87	1H6652	1321.50	Ea.	284.6	LPP

43 Openings

24 - 6" x 6", 9 - 12" x 9", 4 - 9" x 9", 6 - 12" x 12"

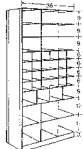

36	12	87	1H6143	728.75	Ea.	147.9	LPP
36	18	87	1H6243	853.20	Ea.	188.3	LPP
36	24	87	1H6343	998.10	Ea.	227.5	LPP

Bin sizes shown (w x h) are nominal unless stated otherwise. Subtract 1-3/16" from bin height for actual clear opening height.

Refer to the previous page for Closed Clipper End Kits.

58 Openings

32 - 6" x 6", 12 - 12" x 9", 4 - 7-1/2" x 9", 2 - 9" x 9", 8 - 12" x 12"

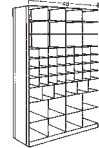

48	12	87	1H6458	980.85	Ea.	189.1	LPP
48	18	87	1H6558	1197.70	Ea.	244.0	LPP
48	24	87	1H6658	1416.70	Ea.	295.6	LPP

13 Openings

12 - 36" x 6", 1 - 36" x 12"

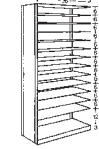

36	12	87	1H6113	552.30	Ea.	146.8	LPP
36	18	87	1H6213	654.80	Ea.	179.1	LPP
36	24	87	1H6313	751.75	Ea.	212.8	LPP

13 Openings

12 - 48" x 6", 1 - 48" x 12"



48	12	87	1H6413	711.45	Ea.	183.6	LPP
48	18	87	1H6513	908.45	Ea.	226.1	LPP
48	24	87	1H6613	1060.70	Ea.	268.5	LPP

37 Openings

24 - 9" x 6", 4 - 9" x 12", 9 - 12" x 12"



36	12	87	1H6137	705.75	Ea.	144.8	LPP
36	18	87	1H6237	812.60	Ea.	183.2	LPP
36	24	87	1H6337	954.25	Ea.	220.8	LPP

54 Openings

24 - 7-1/2" x 6", 12 - 9" x 6", 4 - 7-1/2" x 12", 2 - 9" x 12", 12 - 12" x 12"

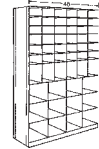

48	12	87	1H6454	986.05	Ea.	187.3	LPP
48	18	87	1H6554	1182.10	Ea.	241.1	LPP
48	24	87	1H6654	1406.70	Ea.	291.8	LPP

21 Openings

21 - 12" x 12", 7 - 3" Bin Fronts

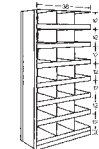

36	12	87	1H6621	627.70	Ea.	133.9	LPP
36	18	87	1H6521	704.50	Ea.	162.8	LPP
36	24	87	1H6421	799.85	Ea.	191.3	LPP

28 Openings

28 - 12" x 12", 7 - 3" Bin Fronts

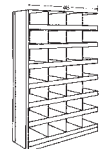

48	12	87	1H6328	819.90	Ea.	170.3	LPP
48	18	87	1H6228	957.35	Ea.	209.4	LPP
48	24	87	1H6128	1101.80	Ea.	246.6	LPP

29 Openings

16 - 9" x 9", 4 - 9" x 12", 9 - 12" x 12", 8 - 3" Bin Fronts

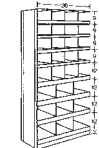

36	12	87	1H6129	721.05	Ea.	147.4	LPP
36	18	87	1H6229	809.80	Ea.	181.2	LPP
36	24	87	1H6329	925.75	Ea.	214.0	LPP

42 Openings

16 - 7-1/2" x 9", 8 - 9" x 9", 4 - 7-1/2" x 12", 2 - 9" x 12", 12 - 12" x 12", 8 - 3" Bin Fronts



48	12	87	1H6442	971.15	Ea.	190.8	LPP
48	18	87	1H6542	1132.20	Ea.	238.0	LPP
48	24	87	1H6642	1314.20	Ea.	282.6	LPP



Clipper Specialty Shelving and Components

W D H * Cat. No. Price Per Wt. Pkg.

Art Work Storage Shelving



Art Work Basic Unit

18 Openings - 18 - 6" x 26-3/4" Clear. Order 24" x 87"
Closed Clipper End Kit separately.

36 24 87 **1H6700 815.50** Ea. 216.5 LPP

Divider For Art Filing

24 28 **15996H 30.25** Ea. 7.0 LPP

X-Ray Storage Shelving

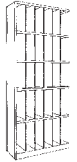

X-Ray Basic Unit

Heavy Duty Hi-Performance
30 Openings - 18 - 6" x 14-3/4", 12 - 6" x 16-3/4" Clear.
For X-Ray jackets up to 14-1/2". Order 18" x 87" Closed
Clipper End Kit separately.

36 18 87 **1H6705 721.60** Ea. 166.2 LPP

Plan Storage Shelving

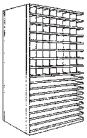

Plan Shelving Basic Unit

73 Openings - 64 - 6" x 6", 9 - 48" x 4". Order 36" x 87"
Closed Clipper End Kit separately.

48 36 87 **1H6659 2175.55** Ea. 561.6 LPP

Plan Shelving Dividers

36 6 **16100H 12.65** Ea. 1.8 LPP

Open Shelf File Shelving



Open Shelf Filing Basic Unit

Uses Standard Flange Clipper Shelves
Order Closed Clipper End Kit separately to finish basic
unit or end a row.

36 12 87 **176709 826.85** Ea. 139.5 LPP

Divider for Open Shelf Filing

Cannot be used with Hi-Performance Shelves.

12 7 **164210C 11.60** Ea. 1.1 LPP

Divider Support

For Open Shelf Filing Units.

36 4 **16421H 15.95** Ea. 2.1 LPP

Closed Clipper End Kits



To End Row of Closed Shelving

12 87 **1C1287 55.80** Ea. 14.1 LPP

18 87 **1C1887 67.30** Ea. 17.5 LPP

24 87 **1C2487 78.85** Ea. 21.0 LPP

36 87 **1C3687 106.10** Ea. 27.8 LPP

Open Ledge Shelving



Open Ledge Basic Unit

Heavy Duty Hi-Performance
Order Ledge Open End Kit separately to finish basic unit
or to end a row.

36 24 87 **1H432L 418.40** Ea. 118.7 LPP

Ledge Open End Kit

12/24 87 **19433E 71.25** Ea. 15.5 LPP

Closed Ledge Shelving



Closed Ledge Basic Unit

Heavy Duty Hi-Performance
Order Ledge Closed End Kit separately to finish basic
unit or to end a row.

36 24 87 **1H434L 522.65** Ea. 143.4 LPP

Ledge Closed End Kit

12/24 87 **19435E 94.95** Ea. 20.9 LPP

Ledge Shelving Components

Ledge Top

36 24 **10538H 100.00** Ea. 27.0 LPP

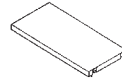

Ledge Top End, LH

24 **13545H 10.90** Ea. 1.6 LPP



Ledge Top End, RH

24 **13546H 10.90** Ea. 1.6 LPP

Counter Shelving

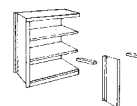

Counter Basic Unit

Heavy Duty Hi-Performance
Order Counter End Kit separately to finish a basic unit or
to end a row. 36" wide packed 1 per 2 cartons. Unit has
Box Posts at front and rear.

36 24 39 **1H122C 338.45** Ea. 96.8

42 24 39 **1H123C 372.80** Ea. 109.1 LPP

48 24 39 **1H124C 432.65** Ea. 121.0 LPP

End Kit, Counter

24 39 **19125E 76.25** Ea. 18.0

Counter Shelving Components

Counter Tops

36 24 **13670H 82.20** Ea. 27.0 LPP

42 24 **13680H 91.80** Ea. 31.0 LPP

48 24 **13690H 102.60** Ea. 35.0 LPP

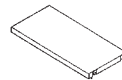

Bin sizes shown (w x h) are nominal unless stated otherwise.
Subtract 1-3/16" from bin height for actual clear opening height.

Clipper Shelving Components



W	D	H *	Cat. No.	Price	Per	Wt.	Pkg.
---	---	-----	----------	-------	-----	-----	------

Counter Fronts



36	39		13870H	77.00	Ea.	19.0	LPP
42	39		13880H	85.45	Ea.	22.0	LPP
48	39		13890H	94.10	Ea.	25.0	LPP

Counter Top Finishing Strip



24			13760H	11.25	Ea.	1.8	LPP
----	--	--	---------------	--------------	-----	-----	-----

Divider Support Angle (Pairs)

Used to support the top of dividers under ledge or counter top. Reduces the required height of the divider by 1".

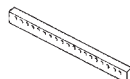

36			17120H	22.00	Pr.	2.3	LPP
----	--	--	---------------	--------------	-----	-----	-----

Box Posts



14 Gauge

39			1B4039C	14.65	Ea.	4.5	10
48			1B4048C	17.75	Ea.	5.0	10
75			1B4075C	27.15	Ea.	7.8	10
87			1B4087C	31.65	Ea.	9.1	10
99			1B4099C	37.80	Ea.	10.3	10
123			1B4123C	46.55	Ea.	12.8	10
147			1B4147C	56.20	Ea.	15.3	10

16 Gauge

Not recommended for Multi-Level Shelving use.

87			1B6087C	27.20	Ea.	6.9	10
----	--	--	----------------	--------------	-----	-----	----

Offset Angle Posts

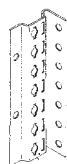

14 Gauge

39			1A4039C	8.35	Ea.	2.8	12
48			1A4048C	9.90	Ea.	3.4	12
75			1A4075C	14.70	Ea.	5.2	12
87			1A4087C	16.85	Ea.	6.1	12
99			1A4099C	21.25	Ea.	6.9	12
123			1A4123C	26.20	Ea.	8.6	12
147			1A4147C	31.65	Ea.	10.2	12

16 Gauge

Not for Multi-Level Shelving use.

87			1A6087C	15.05	Ea.	4.6	12
----	--	--	----------------	--------------	-----	-----	----

Post Splice



With Hardware

6			10030H	3.10	Ea.	0.3	PPO
---	--	--	---------------	-------------	-----	-----	-----

Foot Plate-Floor Protector

Plated

NOT for Multi-Level or High Rise Structures.

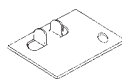

1-3/4	2-5/8		10007Z	0.45	Ea.	0.2	PPO
-------	-------	--	---------------	-------------	-----	-----	-----

Floor Anchor Clip

Anchor holes are 7/16" diameter.

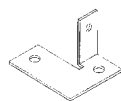

3-1/2	2-7/8		10006Z	3.00	Ea.	0.4	PPO
-------	-------	--	---------------	-------------	-----	-----	-----

Concrete Floor Anchor



3/8" x 2-1/4"

3/8	2-1/4		9280	1.75	Ea.	0.1	PPO
-----	-------	--	-------------	-------------	-----	-----	-----

3/8" x 3-3/4"

Use the longer anchor # 9281 in seismic zones higher than 2A.

3/8	3-3/4		9281	2.40	Ea.	0.2	PPO
-----	-------	--	-------------	-------------	-----	-----	-----

Shim

11 Gauge

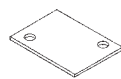

3-1/2	2-7/8		10011	2.40	Ea.	0.4	PPO
-------	-------	--	--------------	-------------	-----	-----	-----

Foot Plate, Clipper, Heavy Duty (7 Ga.)

For Box, Single & Double Angle Posts.

Specify color. Hardware included to fasten to post.



5-1/2	2-3/8		1ACX322H	20.85	Ea.	0.8	PPO
-------	-------	--	-----------------	--------------	-----	-----	-----

Shim for Heavy Duty Foot Plate

(7 Ga.) Specify color.



5-1/2	2-3/8		1ACX330	2.55	Ea.	0.4	PPO
-------	-------	--	----------------	-------------	-----	-----	-----

For Multi-level shelving components and other accessories, see page 11-13

W	D	H	*	Cat. No.	Price	Per	Wt.	Pkg.
---	---	---	---	----------	-------	-----	-----	------

W	D	H	*	Cat. No.	Price	Per	Wt.	Pkg.
---	---	---	---	----------	-------	-----	-----	------

Back Sway Braces (Pair)

For Open Shelving

One pair forms a set which bolts to the short leg of the rear Offset Angle Posts for lateral stability. Can be used in common between back-to-back units. Dimension shown is shelf width.



24		12045A	11.70	Pr.	2.3	20
30		12050A	12.65	Pr.	2.5	20
36		12036H	12.65	Pr.	3.2	20
42		12042H	14.70	Pr.	3.8	20
48		12048H	14.70	Pr.	3.8	20

Side Sway Braces (Pair)

One pair forms a set which bolts to the front and rear posts for stability. Can be used in common between adjoining units. Dimension shown is shelf depth.



9		12011S	7.20	Pr.	0.8	20
12		12015S	7.20	Pr.	1.0	20
15		12019S	8.20	Pr.	1.1	20
18		12026S	8.20	Pr.	1.4	20
24		12034S	9.85	Pr.	1.8	20
30		12045S	12.05	Pr.	2.3	20
32		12046S	12.80	Pr.	2.4	20
36		12049S	12.05	Pr.	2.5	20

Back Panels

For Closed Shelving

Punched on 1" centers at vertical edges and center for attaching to posts & shelves. 36" w backs are furnished in 1 pc. thru 87" h.; over 87", split horizontally. 42" & 48" in 1 pc. thru 51"; 2 pcs. above 51" h. Includes back clip and hardware.

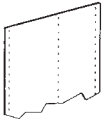

24	87	12340H	61.55	Ea.	14.9	8
30	87	12440H	70.65	Ea.	18.3	6
36	39	12500H	41.30	Ea.	9.4	10
36	51	12510H	52.30	Ea.	12.3	8
36	75	12530H	69.65	Ea.	17.9	6
36	87	12540H	84.70	Ea.	20.9	5
36	99	12550H	104.35	Ea.	23.5	4
42	39	12600H	45.30	Ea.	10.7	5
42	51	12610H	63.00	Ea.	13.9	5
42	75	12630H	90.70	Ea.	21.4	5
42	87	12640H	108.35	Ea.	24.4	5
42	99	12650H	125.95	Ea.	27.8	5
48	39	12700H	55.20	Ea.	12.3	5
48	51	12710H	72.00	Ea.	15.9	5
48	75	12730H	110.25	Ea.	27.9	5
48	87	12740H	127.20	Ea.	28.2	5
48	99	12750H	143.80	Ea.	31.8	5

Side Panels

Side Panels over 87" high are supplied in 2 pieces split horizontally.

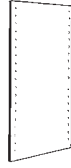

9	87	11340H	19.70	Ea.	3.2	20
12	39	11400H	13.80	Ea.	2.3	25
12	48	11409H	16.30	Ea.	2.8	25
12	51	11410H	16.45	Ea.	3.0	25
12	75	11430H	21.75	Ea.	4.3	20
12	87	11440H	24.15	Ea.	5.0	16
12	99	11450H	33.10	Ea.	5.8	12
15	87	11540H	29.35	Ea.	6.7	14
18	39	11600H	21.30	Ea.	3.9	20
18	48	11609H	24.30	Ea.	4.7	20
18	51	11610H	24.45	Ea.	5.0	20
18	75	11630H	31.95	Ea.	7.3	12
18	87	11640H	35.65	Ea.	8.4	10
18	99	11650H	48.95	Ea.	9.9	10
24	39	11700H	24.45	Ea.	5.4	20
24	51	11710H	31.25	Ea.	7.0	18
24	75	11730H	40.70	Ea.	10.3	8
24	87	11740H	47.20	Ea.	11.9	8
24	99	11750H	62.65	Ea.	13.9	6
30	39	11800H	34.80	Ea.	6.9	14
30	87	11840H	64.35	Ea.	15.2	6
30	99	11850H	92.65	Ea.	17.9	5
36	39	11900H	40.40	Ea.	8.5	10
36	75	11930H	65.60	Ea.	16.2	6
36	87	11940H	74.45	Ea.	18.7	5
36	99	11950H	108.45	Ea.	21.9	5

Closed Upright Assemblies

Side panels and posts factory welded into a single unit. Other heights & depths are available up to 123" high.

Box Post End

12	87	15412CC	86.65	Ea.	22.0	4
18	87	15418CC	97.05	Ea.	25.4	4
24	87	15424CC	111.50	Ea.	28.9	4



Box Post Intermediate

12	87	15412BC	105.25	Ea.	28.7	4
18	87	15418BC	115.50	Ea.	32.2	4
24	87	15424BC	128.65	Ea.	35.6	4



Offset Angle End

12	87	15412AC	64.75	Ea.	18.5	4
18	87	15418AC	74.40	Ea.	22.0	4
24	87	15424AC	89.85	Ea.	25.4	4



Hi-Performance Shelves and Capacities



W	D	H *	Cat. No.	Price	Per	Wt.	Pkg.
---	---	-----	----------	-------	-----	-----	------

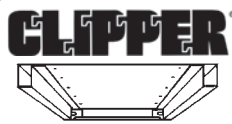

Hi-Performance Shelves
Integral box-beam construction on the front and rear flanges. Capacity is varied on Class 0, 1 & 2 by using thicker steel.

Clipper Shelves, with 4 Clips

SEE SHELF CAPACITIES: Select the proper shelf type for the expected maximum load.

Hi-Performance Medium Duty, Class 0

NOTE: Minimum order of 100 Medium Duty Shelves per order.



36	12	1H223612C	24.25	Ea.	6.1	10
36	15	1H223615C	28.20	Ea.	7.0	10
36	18	1H223618C	29.20	Ea.	7.9	10
36	24	1H223624C	35.25	Ea.	9.8	10
48	12	1H224812C	32.30	Ea.	7.4	10
48	18	1H224818C	44.95	Ea.	9.7	6
48	24	1H224824C	54.25	Ea.	12.1	6

Hi-Performance Heavy Duty, Class 1



36	12	1H203612C	26.40	Ea.	7.3	10
36	15	1H203615C	31.30	Ea.	8.4	10
36	18	1H203618C	32.90	Ea.	9.5	10
36	24	1H203624C	39.00	Ea.	11.6	10
36	30	1H203630C	46.50	Ea.	13.8	6
36	36	1H203636C	52.70	Ea.	16.0	6
42	12	1H204212C	29.90	Ea.	8.3	10
42	15	1H204215C	33.05	Ea.	9.2	6
42	18	1H204218C	36.45	Ea.	10.8	10
42	24	1H204224C	43.95	Ea.	13.3	6
42	30	1H204230C	54.05	Ea.	15.8	6
42	32	1H204232C	57.90	Ea.	15.9	6
42	36	1H204236C	58.30	Ea.	18.3	6
48	12	1H204812C	34.60	Ea.	9.4	10
48	15	1H204815C	41.15	Ea.	10.3	6
48	18	1H204818C	47.85	Ea.	12.2	6
48	24	1H204824C	57.90	Ea.	15.0	6
48	30	1H204830C	62.25	Ea.	17.9	6
48	36	1H204836C	66.10	Ea.	21.7	6

W	D	H *	Cat. No.	Price	Per	Wt.	Pkg.
---	---	-----	----------	-------	-----	-----	------

Hi-Performance Extra Heavy Duty, Class 2

Can be converted to Class 3 Shelf by adding center support and side shelf supports.





36	12	1H183612C	35.30	Ea.	9.9	10
36	15	1H183615C	40.95	Ea.	11.5	10
36	18	1H183618C	43.00	Ea.	13.0	10
36	24	1H183624C	51.65	Ea.	16.0	10
36	30	1H183630C	62.75	Ea.	19.0	6
36	36	1H183636C	74.50	Ea.	22.0	6
42	12	1H184212C	40.65	Ea.	11.4	10
42	15	1H184215C	47.65	Ea.	12.9	6
42	18	1H184218C	51.85	Ea.	14.9	10
42	24	1H184224C	61.65	Ea.	18.4	6
42	30	1H184230C	74.50	Ea.	21.9	6
42	32	1H184232C	78.75	Ea.	22.5	6
42	36	1H184236C	85.00	Ea.	24.8	6
48	12	1H184812C	45.60	Ea.	12.9	10
48	15	1H184815C	53.10	Ea.	14.6	6
48	18	1H184818C	58.40	Ea.	16.8	6
48	24	1H184824C	71.00	Ea.	20.8	6
48	30	1H184830C	83.50	Ea.	24.7	6
48	36	1H184836C	95.60	Ea.	28.7	6

MEDIUM Duty Class "0" Hi-Performance shelves are available on production runs, the minimum order quantity being 100 shelves for each catalog size.

Wire Shelves are available as an alternative to Clipper Shelving. Contact your Penco representative for pricing. Clipper Clips must be purchased separately.

Clipper Hi-Performance® Shelf Capacities

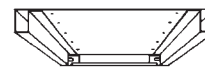
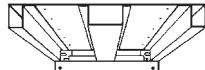
		 Class 0 Medium Duty High Strength Steel		 Class 1 Heavy Duty High Strength Steel		 Class 2 Extra Heavy Duty High Strength Steel		 Class 3 Extra Heavy Duty With Reinforcing*		
Width	Depth	Cat. No.	Capacity	Cat. No.	Capacity	Cat. No.	Capacity	Capacity		
36"	12"	1H223612C	500 lb	1H203612C	800 lb	1H183612C	1100 lb	-		
	15"	1H223615C	500 lb	1H203615C	800 lb	1H183615C	1100 lb	-		
	18"	1H223618C	500 lb	1H203618C	850 lb	1H183618C	1200 lb	2000 lb		
	24"	1H223624C	500 lb	1H203624C	800 lb	1H183624C	1250 lb	2000 lb		
	30"	-	-	-	1H203630C	500 lb	1H183630C	900 lb	2000 lb	
	36"	-	-	-	1H203636C	500 lb	1H183636C	900 lb	2000 lb	
42"	12"	-	-	1H204212C	600 lb	1H184212C	1100 lb	-		
	15"	-	-	1H204215C	600 lb	1H184215C	1100 lb	-		
	18"	-	-	1H204218C	600 lb	1H184218C	1050 lb	1600 lb		
	24"	-	-	1H204224C	600 lb	1H184224C	900 lb	1600 lb		
	30"	-	-	1H204230C	625 lb	1H184230C	1000 lb	1600 lb		
	32"	-	-	1H204232C	525 lb	1H184232C	950 lb	1600 lb		
48"	36"	-	-	1H204236C	475 lb	1H184236C	900 lb	1600 lb		
	12"	1H224812C	350 lb	1H204812C	500 lb	1H184812C	750 lb	-		
	15"	-	-	1H204815C	500 lb	1H184815C	850 lb	-		
	18"	1H224818C	375 lb	1H204818C	500 lb	1H184818C	900 lb	1200 lb		
	24"	1H224824C	400 lb	1H204824C	500 lb	1H184824C	900 lb	1200 lb		
	30"	-	-	-	1H204830C	500 lb	1H184830C	750 lb	1200 lb	
36"	-	-	-	1H204836C	500 lb	1H184836C	750 lb	1200 lb		

All figures shown are shelf load capacities in pounds for evenly distributed loads and include a safety factor of 1.65. Recommend Heavy Duty or Extra Heavy Duty for shelving requirements larger than 36"x 24". Note: (1) : Class 3 capacities are based upon the use of Extra Heavy Duty Shelves with (A) Side Shelf Supports and (B) Center Support for additional capacity. Must use nuts and bolts for shelves, not clips.

W	D	H	*	Cat. No.	Price	Per	Wt.	Pkg.
---	---	---	---	----------	-------	-----	-----	------

W	D	H	*	Cat. No.	Price	Per	Wt.	Pkg.
---	---	---	---	----------	-------	-----	-----	------

Class 3 Shelf Supports

Center Support

Runs left to right beneath the mid-point of the shelf for conversion to Class 3. Supported by side shelf supports.

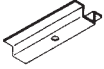

36		H13736C	15.10	Ea.	3.9	20
42		H13742C	16.40	Ea.	4.6	20
48		H13748C	17.75	Ea.	5.2	20

Side Shelf Support (Pair)

Supports center support in Class 3 applications.



18		1H830H	31.10	Pr.	2.9	10
24		1H840H	32.45	Pr.	3.9	10
30		1H850H	36.25	Pr.	4.9	10
36		1H860H	38.20	Pr.	5.9	10

Shelving Doors

With Lock & 2 keys

Standard Swinging Doors cannot be used on shelving with Modular Drawers.



36	36	19600H	293.35	Pr.	37.0	PPO
36	48	19610H	328.70	Pr.	49.0	PPO
36	73	19630H	436.70	Pr.	67.0	PPO
36	85	19640H	475.35	Pr.	65.0	PPO
48	36	19646H	513.35	Pr.	32.5	PPO
48	85	19650H	583.70	Pr.	89.0	PPO

Sliding Doors

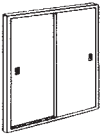

(set of 2)

Flanged on all 4 sides and reinforced. Doors slide on quiet, smooth-running nylon rollers and guides. Complete with grooved key cylinder lock w/keys, mounting channels & universal clips. Designed for use in side by side models with shelf at top.

72	36	1H907236	828.30	Pr.	64.1	PPO
72	84	1H907284	1038.20	Pr.	123.0	PPO

Front Base Strips



Fastens directly to the bottom shelf front to close the gap beneath it and the floor. Normally used with closed shelving. Includes hardware.

24	3	14500H	7.60	Ea.	0.8	10
30	3	14510H	8.30	Ea.	1.1	10
36	3	14520H	8.50	Ea.	1.6	10
42	3	14530H	9.95	Ea.	1.8	10
48	3	14540H	10.35	Ea.	2.0	10

Label Holders

Punched for attaching to the front flange of shelves.

Accepts 7/8" high labels. Attaches with plastic button fasteners (included).

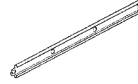

24		13900H	2.45	Ea.	0.3	100
30		13910H	2.80	Ea.	0.3	100
36		13920H	2.80	Ea.	0.4	100
42		13930H	3.00	Ea.	0.4	100
48		13940H	3.30	Ea.	0.5	100

Bin Fronts

Hardware included for fastening to front of shelf.

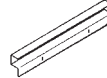

36	1	14210H	12.60	Ea.	1.6	10
36	2	14220H	13.80	Ea.	2.0	10

Hardware included for clipping between posts.

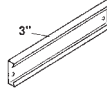

36	3	14230C	14.70	Ea.	2.2	10
42	3	14330C	15.80	Ea.	2.5	10
48	3	14430C	17.10	Ea.	2.8	10

Full Height Dividers

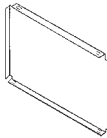

Front edge beaded; top, bottom and rear edges flanged.

Attaches with plastic button fasteners (included). For Class 3 use, contact your representative regarding special notching.

12	6	15600H	7.20	Ea.	0.6	PPO
12	9	15620H	8.25	Ea.	0.8	PPO
12	12	15640H	9.35	Ea.	1.0	PPO
12	14	15650H	11.35	Ea.	1.2	PPO
12	18	15670H	13.50	Ea.	1.5	PPO
15	6	15700H	8.80	Ea.	0.8	PPO
15	9	15720H	8.95	Ea.	1.4	PPO
15	12	15740H	9.75	Ea.	1.4	PPO
18	6	15800H	8.70	Ea.	0.9	PPO
18	9	15820H	9.10	Ea.	1.3	PPO
18	10	15830H	9.45	Ea.	1.4	PPO
18	12	15840H	10.30	Ea.	1.7	PPO
18	16	15860H	12.40	Ea.	2.2	PPO
18	18	15870H	14.40	Ea.	2.4	PPO
18	24	15890H	20.15	Ea.	4.8	PPO
24	6	15900H	10.50	Ea.	1.2	PPO
24	9	15920H	11.35	Ea.	1.7	PPO
24	12	15940H	12.80	Ea.	2.2	PPO
24	18	15970H	17.85	Ea.	3.2	PPO
24	24	15990H	25.30	Ea.	6.2	PPO
36	6	16100H	12.65	Ea.	1.8	PPO
36	9	16120H	12.20	Ea.	2.4	PPO
36	12	16140H	16.05	Ea.	3.1	PPO
36	18	16170H	22.45	Ea.	4.7	PPO
36	24	16180H	31.40	Ea.	9.1	PPO

W	D	H	*	Cat. No.	Price	Per	Wt.	Pkg.
---	---	---	---	----------	-------	-----	-----	------

W	D	H	*	Cat. No.	Price	Per	Wt.	Pkg.
---	---	---	---	----------	-------	-----	-----	------

Partial Dividers



Partitions shelves from front to rear. Flanged and punched for shelf attachment. Has rounded top corners for safety. Attaches with plastic button fasteners (included).

12	2			16395H	5.30	Ea.	0.4	PPO
12	4			16410H	5.60	Ea.	0.7	PPO
18	2			16397H	6.40	Ea.	0.6	PPO
18	4			16430H	6.60	Ea.	1.1	PPO
24	4			16440H	8.40	Ea.	1.5	PPO

Sliding Dividers

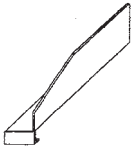

For Hi-Performance Shelves ONLY

Formed to fit around front and over rear edges of shelf. Can be positioned horizontally anywhere along shelf surface. No hardware required. Medium & Heavy Duty Hi-Performance shelves only (NOT for Conv. Flange shelf or Extra HD).

12	4			1H4124C	9.45	Ea.	1.0	PPO
12	6			1H4126C	9.80	Ea.	1.3	PPO
18	4			1H4184C	10.80	Ea.	1.5	PPO
18	6			1H4186C	12.10	Ea.	1.9	PPO
24	4			1H4244C	15.30	Ea.	1.9	PPO
24	6			1H4246C	15.70	Ea.	2.4	PPO

Shelf Boxes

Has integral full finger grip and embossed label holder. Slotted on 1" centers for dividers. Back stop minimizes accidental removal of drawer. Depth dimension nominal. Boxes per 36" wide shelf: 6" wide, 6; 8" wide, 4; 11" wide, 3.



028 Gray is Standard

Order Box Dividers separately.

5-5/8	11	4-5/8		38030C	22.20	Ea.	2.9	12
8-7/16	11	4-5/8		38035C	30.35	Ea.	3.4	8
11-1/4	11	4-5/8		38040C	32.50	Ea.	5.5	6
5-5/8	17	4-5/8		38180C	28.65	Ea.	3.9	12
8-7/16	17	4-5/8		38185C	33.55	Ea.	4.7	8
11-1/4	17	4-5/8		38190C	37.35	Ea.	6.0	6
5-5/8	23	4-5/8		38255C	35.70	Ea.	4.9	12
8-7/16	23	4-5/8		38260C	37.45	Ea.	6.0	8
11-1/4	23	4-5/8		38265C	48.25	Ea.	7.4	6

Divider, Shelf Boxes



For quick and easy partitioning of shelf boxes on 1" centers. Galvanized steel.

5-5/8		4-1/2		38306	1.80	Ea.	0.3	10
8-7/16		4-1/2		38307	2.30	Ea.	0.4	10
11-1/4		4-1/2		38308	3.10	Ea.	0.6	10

Shelf Box Guide (Ea.)

Guides shelf box to prevent snagging on post. Order 2 guides for each full shelf of shelf boxes.

For Shelf Boxes - 028 Gray is Standard

10038H028	1.00	Ea.	0.1	PPO
-----------	------	-----	-----	-----



Coat Rod Bracket

18		14705H	9.55	Ea.	1.5	PPO
24		14706H	12.65	Ea.	2.0	PPO
36		14708H	19.00	Ea.	3.0	PPO

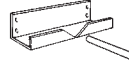

Coat Rod - 3/4" Galvanized Pipe

36		9405C	14.05	Ea.	3.5	PPO
48		9406C	19.50	Ea.	4.7	PPO

Finished End Panels

For use with Box front posts.

12	87	18241H	56.20	Ea.	15.0	PPO
18	87	18440H	82.25	Ea.	26.0	PPO
24	87	18540H	116.95	Ea.	31.0	PPO



Multi-Level Shelving Parts

Multi-Level Support W/Hardware

LH or RH All Except Box Post

5		10062H	8.40	Ea.	0.9	PPO
---	--	---------------	-------------	-----	-----	-----

LH or RH Box Post Only

5		10063H	8.40	Ea.	0.6	PPO
---	--	---------------	-------------	-----	-----	-----

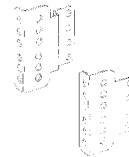

Cross Aisle Supports

30	4	85130H	23.65	Ea.	4.7
36	4	85136H	25.45	Ea.	5.5
42	4	85142H	27.20	Ea.	6.3
48	4	85148H	32.45	Ea.	10.6

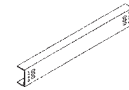

Grating Support Channels

30	4	85230H	22.75	Ea.	4.4
36	4	85236H	25.35	Ea.	5.3
42	4	85242H	26.05	Ea.	6.0
48	4	85248H	30.70	Ea.	10.0

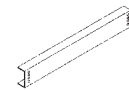

Grating Support Hanger

3	2	4	85201C	6.20	Ea.	0.9
---	---	---	---------------	-------------	-----	-----





Channel Lock Safety Grating

W	D	H	*	Cat. No.	Price	Per	Wt.	Pkg.
---	---	---	---	----------	-------	-----	-----	------

Grating Support Angle

1	2	4		85200C	3.65	Ea.	0.4	
---	---	---	--	--------	------	-----	-----	--



Post Assembly

3	2-1/4	87		84087C	150.65	Ea.	25.0	
3	2-1/4	99		84099C	167.35	Ea.	28.0	

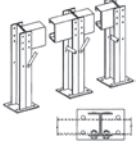

5" High Beam

To be used with Post Assembly. Maximum 93" Long.

93	2	5		85293C	69.90	Ea.	31.0	
----	---	---	--	--------	-------	-----	------	--



End of Aisle Kickplate

For Clipper & Erectomatic Posts

30		4		H2KP30	20.80	Ea.	4.8	
36		4		H2KP36	22.50	Ea.	5.6	
42		4		H2KP42	25.60	Ea.	6.4	
48		4		H2KP48	26.55	Ea.	7.3	



Channel Lock Grating, 16 Ga.

Actual size of top of grating is 8-7/8". GRATING CONVERSION FACTORS: To convert Sq. Ft. to 9" wide linear feet; Multiply Sq. Ft. x 1.35. To convert 9" wide linear feet to square feet; Multiply Linear Ft. x .74.

Male/Female

Interlocks on both sides. Galvanized Finish.

72	8-7/8	2		8AL072C	49.40	Ea.	19.0	
108	8-7/8	2		8AL108C	73.10	Ea.	28.0	
144	8-7/8	2		8AL144	97.10	Ea.	37.0	



Male/Male

For end of row applications. Interlocks on one side only.

Galvanized Finish.

72	8-7/8	2		8GL072C	61.85	Ea.	19.0	
108	8-7/8	2		8GL108C	90.10	Ea.	28.0	
144	8-7/8	2		8GL144	118.25	Ea.	37.0	



Grating Fillers

Galvanized

Tek screws may be required for fastening.

72	3	2		8FK072C	38.65	Ea.	8.5	
108	3	2		8FK108C	58.75	Ea.	12.8	
144	3	2		8FK144	75.90	Ea.	17.0	



W	D	H	*	Cat. No.	Price	Per	Wt.	Pkg.
---	---	---	---	----------	-------	-----	-----	------

Grating Splice Angle

12				8SP012C	7.05	Ea.	1.0	
----	--	--	--	---------	------	-----	-----	--



Grating Hardware Kit Bag of 50 Nuts and Bolts

5/16" x 5/8" Hex Head Bolts with Hex Nuts. Order four nuts and bolts per plank.

82201	13.85	50		2.0	50
-------	-------	----	--	-----	----

Grating "J" Bolts

Bag of 50 With Nuts

Order one bag per 200 square feet of grating.

82200	35.55	50		4.0	50
-------	-------	----	--	-----	----

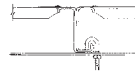

Grating Hold Down Clips

With Tek Screw

Must use power tool with extension.

8HC00H	1.55	Ea.	0.1
--------	------	-----	-----

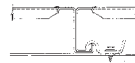

W	D	H	*	Cat. No.	Price	Per	Wt.	Pkg.
---	---	---	---	----------	-------	-----	-----	------

Handrail/Parts: Multi-Level Shelving

Available with posts for 2 rails and 3 rails. Finished in 710 Yellow. Use only with Penco Channel-Lock Grating. For handrail with other types of decking, contact your representative.

Post, Left Hand End, 2 Rails

42 85204A 74.00 Ea. 10.5

Post, Left Hand End, 3 Rails

42 85205A 80.10 Ea. 10.7

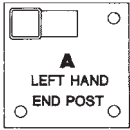

Post, Right Hand End, 2 Rails

42 85204B 74.00 Ea. 10.5

Post, Right Hand End, 3 Rails

42 85205B 80.10 Ea. 10.7

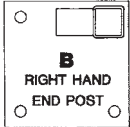

Post, Intermediate, 2 Rails

42 85204C 87.20 Ea. 11.2

Post, Intermediate, 3 Rails

42 85205C 98.80 Ea. 11.4

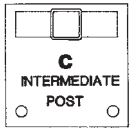

Post, Outside Corner, 2 Rails

42 85204D 86.95 Ea. 11.0

Post, Outside Corner, 3 Rails

42 85205D 98.80 Ea. 11.4

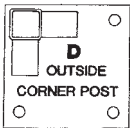

Post, Inside Corner, 2 Rails

42 85204E 86.95 Ea. 11.0

Post, Inside Corner, 3 Rails

42 85205E 98.80 Ea. 11.4

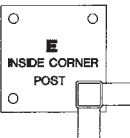

Handrail - Nominal 6' Section

72 852066C 34.10 Ea. 9.6

Kick Plate

Standard Nominal 6' Length

72 850072C 24.25 Ea. 9.2

End Of Aisle Handrail Bracket

Order 2 Per Pc. of Handrail

85207H 13.95 Ea. 1.0

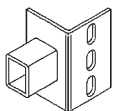

Two Rail Post illustrated: two and three rail models are available

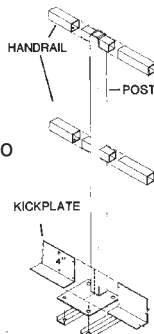

Replacement Hardware

W	D	H	*	Cat. No.	Price	Per	Wt.	Pkg.
---	---	---	---	----------	-------	-----	-----	------

Clipper Hi-Performance Shelf Clip

For Hi-Performance Shelves

10002Z 0.45 Ea. 0.1 PPO



Clipper Standard Shelf Clip

For Standard Flange Shelves

100001Z 0.45 Ea. 0.1 PPO



Plastic Button

For attaching various shelving accessories such as dividers and label holders. Normally included with shipment; order here for replacement only.

8401 0.10 Ea. 0.1 PPO



Back Panel Clip

Formed to fit the bottom flange of the shelf and tabbed to insert in holes in center of back panel. Holds back panel to shelf. Order as replacement part only.

H120 0.70 Ea. 0.1 PPO



Bin Front Clip, For 3" h Bin Fronts

Order as replacement part only.

10037Z 1.00 Ea. 0.1 PPO

Machine Screw, 1/4-20 x 1-1/4" TR HD

1-1/4 8101H 10.65 100 4.0 100

Machine Screw, 5/16-18 x 1-1/4" TR HD

1-1/4 8102H 19.90 100 6.0 100

Pan Head Screw, 1/4-20 x 1/2"

1/2 8412H 6.05 100 2.0 100

Slotted Truss Head Mach. Bolt, 1/4-20 x 3/4"

3/4 8410H 9.20 100 2.3 100

Hex Nuts 1/4"-20

8473H 3.10 100 1.5 100

Machine Screw, 1/4-20 x 1" TR HD

1 8415H 9.20 100 3.0 100

Machine Screw, 5/16-18 X 1/2" TR HD

1/2 8455H 12.25 100 3.5 100

Hex Nuts 5/16" - 18

8459H 6.05 100 2.0 100

Stairs and Stair Structures are Available from our sister company, Schmidt Structural Products

All applications involving stairs are reviewed individually and designed to meet or exceed local, state and federal codes in effect at the location where the stairs are to be installed.



Wide Span Shelving Units

W	D	H	*	Cat. No.	Price	Per	Wt.	Pkg.
---	---	---	---	----------	-------	-----	-----	------

W	D	H	*	Cat. No.	Price	Per	Wt.	Pkg.
---	---	---	---	----------	-------	-----	-----	------

Wide Span Basic Units with Steel Shelves Consist of:

- 1 Upright Frame,
- 2 or 3 levels of Steel Shelves,
- 2 or 3 pairs of Side Shelf Supports,
- 2 pairs of Rigidity Beams.

Order the appropriate size Upright Frame to end each unit or group of units separately!

Wide Span Units for Wood Deck Consist of:

- 1 Upright Frame,
- 3 pairs of Plywood Beams,
- Plywood Support Angles (3 per pair of 72-1/2" beams, 4 per pair of 96-1/2" beams).

Order the appropriate size Upright Frame to end each unit or group of units separately!

Wide Span Shelving Basic Units

To end a row or unit of Wide Span Shelving order the appropriate size Upright Frame separately.

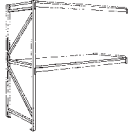

With 2 Steel Shelves

60	30	72	20351	489.90	Unit	147.0	LPP
72	30	72	20353	534.00	Unit	168.0	LPP
84	30	72	20355	583.95	Unit	189.0	LPP
96	30	72	20357	631.20	Unit	210.0	LPP
60	30	96	20383	515.05	Unit	154.0	LPP
72	30	96	20385	559.20	Unit	175.0	LPP
84	30	96	20387	609.05	Unit	196.0	LPP
96	30	96	20389	656.35	Unit	217.0	LPP
60	36	72	20359	550.90	Unit	169.0	LPP
72	36	72	20361	604.85	Unit	193.0	LPP
84	36	72	20363	662.70	Unit	217.0	LPP
96	36	72	20365	716.35	Unit	241.0	LPP
60	36	96	20391	577.40	Unit	177.0	LPP
72	36	96	20393	631.35	Unit	202.0	LPP
84	36	96	20395	689.15	Unit	226.0	LPP
96	36	96	20397	742.90	Unit	250.0	LPP
60	48	72	20375	618.60	Unit	196.0	LPP
72	48	72	20377	680.70	Unit	224.0	LPP
84	48	72	20379	759.10	Unit	252.0	LPP
96	48	72	20381	817.75	Unit	280.0	LPP
60	48	96	20407	647.20	Unit	205.0	LPP
72	48	96	20409	709.45	Unit	233.0	LPP
84	48	96	20411	787.50	Unit	261.0	LPP
96	48	96	20413	846.50	Unit	289.0	LPP



With 3 Steel Shelves

60	30	120	20415	671.90	Unit	207.0	LPP
72	30	120	20417	732.55	Unit	235.0	LPP
84	30	120	20419	801.30	Unit	264.0	LPP
96	30	120	20421	865.70	Unit	292.0	LPP
60	30	144	20447	702.50	Unit	214.0	LPP
72	30	144	20449	763.05	Unit	243.0	LPP
84	30	144	20451	831.40	Unit	271.0	LPP
96	30	144	20453	896.30	Unit	300.0	LPP
60	36	120	20423	764.65	Unit	240.0	LPP
72	36	120	20425	839.45	Unit	302.0	LPP
84	36	120	20427	920.45	Unit	307.0	LPP
96	36	120	20429	994.70	Unit	341.0	LPP
60	36	144	20455	796.80	Unit	249.0	LPP
72	36	144	20457	871.70	Unit	282.0	LPP
84	36	144	20459	952.60	Unit	316.0	LPP
96	36	144	20461	1026.80	Unit	350.0	LPP
60	48	120	20439	864.75	Unit	280.0	LPP
72	48	120	20441	951.80	Unit	320.0	LPP
84	48	120	20443	1063.40	Unit	359.0	LPP
96	48	120	20445	1145.40	Unit	398.0	LPP
60	48	144	20471	898.20	Unit	289.0	LPP
72	48	144	20473	985.10	Unit	328.0	LPP
84	48	144	20475	1097.10	Unit	367.0	LPP
96	48	144	20477	1178.85	Unit	407.0	LPP

Wide Span Units For Wood Deck

To end a row or unit of Wide Span Shelving order the appropriate size Upright Frame separately. Deck material NOT included.



With 3 Beam Levels

72-1/2	48	120	20512	482.50	Unit	136.0	LPP
72-1/2	48	144	20535	515.90	Unit	145.0	LPP
96-1/2	48	120	20514	554.00	Unit	167.0	LPP
96-1/2	48	144	20537	587.60	Unit	175.0	LPP

Tire Rack Units

For passenger car tires. Units have tire beams on aisle side; rigidity beams at rear. Order Upright Frames Separately.

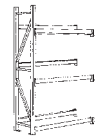

Basic Units, Single Entry

60	18	96	20651	290.80	Unit	84.0	LPP
60	18	126	20653	371.10	Unit	106.0	LPP
60	18	156	20655	480.80	Unit	132.0	LPP
60	18	192	20657	563.60	Unit	159.0	LPP

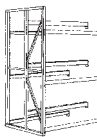

Basic Units, Double Entry

60	38	96	20659	461.50	Unit	124.0	LPP
60	38	126	20661	577.40	Unit	161.0	LPP
60	38	156	20663	708.25	Unit	201.0	LPP
60	38	192	20665	840.75	Unit	241.0	LPP

Wide Span Tire Rack Unit Tire Capacities

Width (in.)	Depth (in.)	Height (in.)	Number of Tiers	Number of Tires
Single Entry Tire Racks				
60	18	96	3	24
60	18	126	4	32
60	18	156	5	40
60	18	192	6	48
Double Entry Tire Racks				
60	38	96	3	48
60	38	126	4	64
60	38	156	5	80
60	38	192	6	96

Tire storage capacities based on average passenger size tires.

Traditional color is 028 Gray, however all Penco standard colors are available. For Row Spacers and Wall Brackets, see Pallet Rack Accessories. ** Wide Span Upright capacity of 7,500 lbs. based on maximum vertical distance of 60" between floor and beam, or between beam and beam.

Wide Span Shelving Components



W	D	H *	Cat. No.	Price	Per	Wt.	Pkg.
---	---	-----	----------	-------	-----	-----	------

W	D	H *	Cat. No.	Price	Per	Wt.	Pkg.
---	---	-----	----------	-------	-----	-----	------

Wide Span Upright Frames

7,500 LB. CAPACITY**. Order to end a row or basic unit, and when building units from piece parts.

36" High (with Splices)

36" high units are designed to provide additional height when used with standard uprights; e.g. a 72" upright plus a 36" upright obtains a 108" high upright.



24	36	20081C	72.95	Ea.	13.4	PPO
30	36	20082C	74.50	Ea.	14.2	PPO
36	36	20083C	75.95	Ea.	14.9	PPO
42	36	20084C	79.20	Ea.	15.6	PPO
48	36	20085C	80.85	Ea.	16.4	PPO
50	36	2P036C	81.30	Ea.	16.7	PPO

72" & 84" High (with Footplates)



18	72	20000C	86.40	Ea.	19.8	PPO
24	72	20001C	87.65	Ea.	20.6	PPO
30	72	20002C	88.50	Ea.	21.1	PPO
36	72	20003C	89.35	Ea.	21.6	PPO
42	72	20004C	91.60	Ea.	22.1	PPO
48	72	20005C	93.85	Ea.	23.3	PPO
50	72	2P072C	94.20	Ea.	23.5	PPO
18	84	20008C	110.00	Ea.	22.3	PPO
24	84	20009C	111.25	Ea.	23.4	PPO
30	84	20010C	112.45	Ea.	24.1	PPO
36	84	20011C	115.15	Ea.	24.6	PPO
42	84	20012C	118.50	Ea.	25.1	PPO
48	84	20013C	121.65	Ea.	29.0	PPO
50	84	2P084C	121.95	Ea.	29.2	PPO

96" & 120" High (with Footplates)



18	96	20016C	111.10	Ea.	26.7	PPO
24	96	20017C	112.25	Ea.	27.7	PPO
30	96	20018C	113.55	Ea.	28.5	PPO
36	96	20019C	116.00	Ea.	30.4	PPO
42	96	20020C	119.75	Ea.	31.2	PPO
48	96	20021C	122.65	Ea.	32.5	PPO
50	96	2P096C	123.15	Ea.	32.8	PPO
18	120	20032C	127.65	Ea.	33.0	PPO
24	120	20033C	129.25	Ea.	34.0	PPO
30	120	20034C	130.35	Ea.	34.8	PPO
36	120	20035C	133.00	Ea.	36.1	PPO
42	120	20036C	135.25	Ea.	36.9	PPO
48	120	20037C	138.10	Ea.	38.5	PPO
50	120	2P020C	138.65	Ea.	38.8	PPO

144" To 192" High (with Footplates)

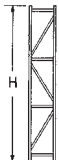

18	144	20048C	156.30	Ea.	39.4	PPO
24	144	20049C	158.05	Ea.	40.8	PPO
30	144	20050C	160.95	Ea.	42.4	PPO
36	144	20051C	165.10	Ea.	43.7	PPO
42	144	20052C	168.35	Ea.	45.6	PPO
48	144	20053C	171.45	Ea.	47.3	PPO
50	144	2P044C	173.30	Ea.	47.6	PPO
24	168	20065C	192.15	Ea.	47.7	PPO
30	168	20066C	193.70	Ea.	48.7	PPO
36	168	20067C	195.80	Ea.	49.7	PPO
42	168	20068C	203.20	Ea.	50.7	PPO
48	168	20069C	206.85	Ea.	52.9	PPO
50	168	2P068C	207.85	Ea.	53.2	PPO
24	192	24001C	207.50	Ea.	52.6	PPO
30	192	24002C	210.35	Ea.	54.8	PPO
36	192	24003C	213.40	Ea.	56.7	PPO
42	192	24004C	219.95	Ea.	58.2	PPO
48	192	24005C	223.35	Ea.	59.9	PPO
50	192	2P092C	224.40	Ea.	60.2	PPO

Tire Rack Upright Frames

For Single Entry Units (with Footplates)

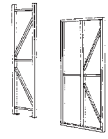

18	96	20016C	111.10	Ea.	26.7	PPO
18	126	20260C	131.60	Ea.	35.0	PPO
18	156	20056C	181.30	Ea.	43.0	PPO
18	192	24040C	204.20	Ea.	56.0	PPO

For Double Entry Units

38	96	20262C	192.80	Ea.	47.0	PPO
38	126	20263C	219.35	Ea.	57.0	PPO
38	156	20264C	260.55	Ea.	68.0	PPO
38	192	20265C	303.60	Ea.	94.0	PPO

Wide Span Upright Frame Accessories

Upright Frame Splice

Note that TWO splices must be ordered per frame. Top upright frame MUST be ordered without footplate. Hardware included.

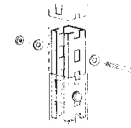

8	20099H	8.85	Ea.	1.0	PPO
---	---------------	-------------	-----	-----	-----

Shim, unpainted

2-1/4 3-1/2	20100C	1.55	Ea.	0.3	PPO
-------------	---------------	-------------	-----	-----	-----



Concrete Floor Anchor

Use the longer anchor # 9281 in seismic zones above 2A.

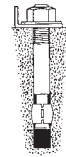

3/8	2-1/4	9280	1.75	Ea.	0.1	PPO
-----	-------	-------------	-------------	-----	-----	-----

Traditional color is 028 Gray, however all Penco standard colors are available. For Row Spacers and Wall Brackets, see Pallet Rack Accessories.** Wide Span Upright capacity of 7,500 lbs. based on maximum vertical distance of 60" between floor and beam, or between beam and beam.



Wide Span Beams and Supports

W	D	H	*	Cat. No.	Price	Per	Wt.	Pkg.
---	---	---	---	----------	-------	-----	-----	------

W	D	H	*	Cat. No.	Price	Per	Wt.	Pkg.
---	---	---	---	----------	-------	-----	-----	------

Wide Span Beams

Add 1/4" to beam width to obtain clearance between upright frames.

Rigidity Beams (Pairs)



48	20315	55.05	Pr.	13.9 PPO
60	20316	60.60	Pr.	16.8 PPO
72	20317	66.55	Pr.	18.7 PPO
84	20318	72.20	Pr.	22.6 PPO
96	20319	78.55	Pr.	25.4 PPO

Standard Plywood Beams (Pairs)

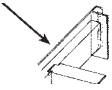

Plywood Support Angles Required

48-1/2	20337	64.70	Pr.	15.9 PPO
60-1/2	20338	74.35	Pr.	19.3 PPO
72-1/2	20339	81.15	Pr.	22.7 PPO
84-1/2	20340	87.35	Pr.	26.0 PPO
96-1/2	20335	93.75	Pr.	29.5 PPO

Heavy Duty Plywood Beams (Pairs)



H.D. Plywood Support/Beam Braces are required. Order Beam Braces based on capacity required. Has 5/8" Step.

48-1/2	210480	73.15	Pr.	20.8 PPO
72-1/2	210720	92.50	Pr.	29.9 PPO
96-1/2	210960	117.45	Pr.	39.0 PPO

Tire Rack Beams (Each)



Beam is slanted to cradle tires. It is designed to be installed on aisle side of unit.

48	20619C	26.85	Ea.	7.0 PPO
60	20620C	29.65	Ea.	8.0 PPO
72	20621C	32.65	Ea.	10.0 PPO

Plywood Support Angles

For Standard Plywood Beam

Use 2 per level of 48-1/2" & 60-1/2" beams; 3 for 72-1/2" & 84-1/2"; 4 for 96-1/2" beams.

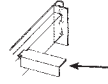

18	20349C	6.10	Ea.	1.2 PPO
24	20341C	6.15	Ea.	1.5 PPO
30	20330C	7.15	Ea.	2.0 PPO
36	20342C	8.00	Ea.	2.5 PPO
42	20332C	10.30	Ea.	2.8 PPO
48	20336C	11.20	Ea.	3.3 PPO

Beam Brace/H.D. Plywood Supports



When Rigidity Beams are used as load bearing members Beam Braces are used to keep beams from twisting.

When used with Heavy Duty Plywood Beams they are used as Plywood Supports. Use a minimum of two per pair of beams.

24	202040C	8.70	Ea.	2.2	12
30	202050C	9.80	Ea.	2.7	12
36	202060C	10.80	Ea.	3.2	12
42	202070C	11.95	Ea.	3.8	12
48	202080C	13.05	Ea.	4.3	12
50	2P0050C	13.50	Ea.	4.5	12

Wide Span Beam Capacities

Beam Type	Size (inches)	Capacity (Lbs.)**
Rigidity Beams (Capacity with Beam Braces- 1 for pair of 60" & 72", 2 per pair of 84" & 96")	48	2500/Pr.
	60	2140/Pr.
	72	1780/Pr.
	84	1580/Pr.
	96	1340/Pr.
Standard Plywood Beams (With Plywood Support Angles)	48-1/2	2500/Pr.
	60-1/2	2120/Pr.
	72-1/2	1760/Pr.
	84-1/2	1500/Pr.
	96-1/2	1350/Pr.
Heavy Duty Plywood Beams (Capacity using Beam Brace/ H.D. Plywood Supports)	48-1/2	2500/Pr.
	72-1/2	2500/Pr.
	96-1/2	2500/Pr.
Tire Rack Beams	48	950 Ea.
	60	800 Ea.
	72	600 Ea.

**Capacities based upon Uniformly Distributed Load, in Pounds.

Wide Span Beam Brace Capacities

Brace Type	Size (inches)	Capacity (Lbs.)**
Beam Brace/Heavy Duty Plywood Support	24	1200 Ea.
	30	1100 Ea.
	36	900 Ea.
	42	700 Ea.
	48	500 Ea.
	50	500 Ea.

**Capacities based upon Uniformly distributed Load, in Pounds.

For Row Spacers and Wall Brackets for Wide Span, use Pallet Rack parts on page 39.

A minimum of two (2) pairs of Rigidity Beams are required for each Wide Span unit. Note that Wide Span Shelves do NOT rest on standard Rigidity or Plywood Beams, but must be supported by Side Shelf supports.

Traditional color is 028 Gray, however all Penco standard colors are available. For Row Spacers and Wall Brackets, see Pallet Rack Accessories.** Wide Span Upright capacity of 7,500 lbs. based on maximum vertical distance of 60" between floor and beam, or between beam and beam.

Wide Span Steel Shelves and Shelf Supports



W	D	H	*	Cat. No.	Price	Per	Wt.	Pkg.
---	---	---	---	----------	-------	-----	-----	------

W	D	H	*	Cat. No.	Price	Per	Wt.	Pkg.
---	---	---	---	----------	-------	-----	-----	------

Wide Span Steel Shelves

Order Side Shelf Supports SEPARATELY

1 pair of Shelf Supports req'd per Shelf.

NOTE: 36" deep shelf is supplied as 2-18" deep shelves;
42" deep shelf is supplied as 1-24" & 1-18" shelf; 48"
shelf is supplied as 2-24" shelves.

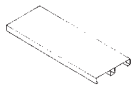

48	18	22418C	61.45	Ea.	18.8	LPP
48	24	22424C	72.00	Ea.	22.6	LPP
48	30	22430C	98.50	Ea.	30.5	LPP
48	36	22436	122.95	Ea.	37.6	LPP
48	42	22442	133.55	Ea.	41.4	LPP
48	48	22448	144.00	Ea.	45.2	LPP
60	18	22518C	70.15	Ea.	23.5	LPP
60	24	22524C	83.15	Ea.	28.3	LPP
60	30	22530C	114.70	Ea.	38.0	LPP
60	36	22536	140.40	Ea.	47.0	LPP
60	42	22542	153.25	Ea.	51.8	LPP
60	48	22548	166.05	Ea.	56.6	LPP
72	18	22618C	80.60	Ea.	28.1	LPP
72	24	22624C	95.55	Ea.	33.9	LPP
72	30	22630C	130.70	Ea.	45.6	LPP
72	36	22636	161.40	Ea.	56.2	LPP
72	42	22642	176.35	Ea.	62.0	LPP
72	48	22648	191.30	Ea.	67.8	LPP
84	18	22718C	92.25	Ea.	32.8	LPP
84	24	22724C	112.30	Ea.	39.5	LPP
84	30	22730C	150.00	Ea.	53.2	LPP
84	36	22736	184.45	Ea.	65.6	LPP
84	42	22742	204.45	Ea.	72.3	LPP
84	48	22748	224.50	Ea.	79.0	LPP
96	18	22818C	102.45	Ea.	37.2	LPP
96	24	22824C	123.85	Ea.	45.1	LPP
96	30	22830C	167.25	Ea.	60.8	LPP
96	36	22836	205.15	Ea.	78.5	LPP
96	42	22842	226.25	Ea.	82.5	LPP
96	48	22848	247.65	Ea.	90.2	LPP

Side Shelf Supports (Pairs)

One Pair Required Per Steel Shelf

Required for units with Steel Shelves!

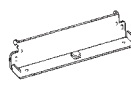

18	22018	21.75	Pr.	5.1	6	Pr.
24	22024	21.95	Pr.	6.8	6	Pr.
30	22030	25.60	Pr.	8.4	6	Pr.
36	22036	29.90	Pr.	10.0	6	Pr.
42	22042	33.65	Pr.	11.6	6	Pr.
48	22048	35.80	Pr.	13.2	6	Pr.

Wide Span Shelf Capacities**					
Shelf Depth (Inches)	48" Wide	60" Wide	72" Wide	84" Wide	96" Wide
18	1200	1200	1000	800	600
24	1500	1200	1000	800	600
30	2300	1800	1500	1200	900
36	2400	2400	2000	1600	1200
42	2000	2000	2000	1600	1200
48	1800	1800	1800	1600	1200

** Capacities based upon Uniformly distributed load, in Pounds

A minimum of two (2) pairs of Rigidity Beams are required for each Wide Span unit using Wide Span Steel Shelves.

Note that Wide Span Shelves do NOT rest on standard Rigidity or Plywood Beams, but must be supported by Side Shelf supports.

A minimum of two (2) pairs of Rigidity Beams are required for each Wide Span unit . Note that Wide Span Shelves do NOT rest on standard Rigidity or Plywood Beams, but must be supported by Side Shelf supports.

Traditional color is 028 Gray, however all Penco standard colors are available. For Row Spacers and Wall Brackets, see Pallet Rack Accessories.
** Wide Span Upright capacity of 7,500 lbs. based on maximum vertical distance of 60" between floor and beam, or between beam and beam.

DESIGN CRITERIA

All units must have a full perimeter of double rivet beams at the top and bottom to insure a stable and rigid unit.

Single Rivet Units

All units using single rivet beams 10'0" to 18'0" in height, require an additional double rivet perimeter beam level located approximately in the middle of the unit.

All single rivet beam units must have one (1) intermediate pair of front to back beams for 7'0" and 8'0" high units and two (2) intermediate pair of front to back beams for 9'0" high units. For 10'0" to 18'0" high units refer to the above paragraph. DO NOT exceed 48" between front to back beams. Single Rivet and

Double front to back beams may be common when using TEE Posts on units up to 8'0" high.

All intermediate single rivet shelves over 24 inches deep must also have single rivet beams supporting the particle board front to back.

Double Rivet Units

All double rivet beam units must have a full perimeter of beams at every level.

Note: All front to back beams must be the same type as the left to right beams in any single level except channel beams.

How To Order RivetRite UNITS

The unit catalog numbers make it easy to order RivetRite without having to compile a bill of material of all component parts. Here is a guide to ordering RivetRite with UNIT catalog numbers.

1. Review the catalog and decide what type of unit will meet your requirement.
2. Determine the shelf size desired and select the capacity needed. Note the capacity shown is for the steel structure only.
3. Next determine the type of shelf deck material and calculate the quantity. Note that none of the unit catalog numbers include decking. (Particle Board decking available from Penco is unfinished and natural in color).
4. The 'traditional' color for all RivetRite steel parts is 723 Light Putty. It is available in any of Penco's standard powder coat colors on a production basis.
5. All starter units are furnished with four Angle Posts. Add-on units have two intermediate Tee Posts. When assembling Starter and Add-on units, put the Angle Posts at the extreme ends of the shelving row. Note that shelving growth will always occur; see growth chart in the RivetRite catalog.
6. If ordering piece parts from the component parts pages of the catalog, see How To Order RivetRite Components, or contact your Penco representative.
7. For faster shipment, see the Penco Quick-SHIP price list: the most popular sizes of most items are available from multiple warehouses in a 723 Light Putty finish.

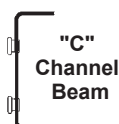

Double Rivet Unit Capacities

Units Without Center Supports

Width	Inches		Shelf Levels Per Unit	Beam Type	Capacity ** (lbs.)
	Depth	Height			
48	18 - 48	84	4	"R" Heavy Duty Angle	750
60	18 - 48	84	4	"R" Heavy Duty Angle	600
72	18 - 48	84	4	"R" Heavy Duty Angle	500
72	30 - 48	120	5	"R" Heavy Duty Angle	500

Units With Center Supports

48	18 - 24	84	4	"R" Heavy Duty Angle	1400
48	30	84	4	"R" Heavy Duty Angle	1310
48	36	84	4	"R" Heavy Duty Angle	1220
48	48	84	4	"R" Heavy Duty Angle	1125
60	18 - 48	84	4	"R" Heavy Duty Angle	1200
60	18 - 48	84	4	"C" Channel	2240 (1)
72	18 - 48	84	4	"R" Heavy Duty Angle	1000
72	18 - 48	84	4	"C" Channel	1850
96	18 - 48	84	4	"R" Heavy Duty Angle	620
96	18 - 48	84	4	"C" Channel	1400
72	30 - 48	120	5	"R" Heavy Duty Angle	1000
72	30 - 48	120	5	"C" Channel	1850 (2)
96	30 - 48	120	5	"R" Heavy Duty Angle	620
96	30 - 48	120	5	"C" Channel	1400

** Capacities for the steel support beams per level, not the shelf deck material. They are expressed in pounds for uniformly distributed loads.

NOTE: Units with Channel Beams are furnished with Heavy Duty Angle Beams at floor level.

(1) - Maximum Average Shelf Load 2000 lbs. per shelf.

(2) - Maximum Average Shelf Load 1490 lbs. per shelf

* NOTES: Traditional Color is 723 Light Putty, however all standard colors are available. Color selection must be made on the order.

All Unit Catalog Numbers are for Steel Framing only. Order deck material separately.

W	D	H	*	Cat. No.	Price	Per	Wt.	Pkg.
---	---	---	---	----------	-------	-----	-----	------

Double Rivet Units without Center Supports Consist of:

Starter Units

- 4 Standard Angle Posts (Up to and including 144" high)
- 2 Double Rivet Angle Beams left to right per shelf level
- 2 Double Rivet Angle Beams front to back per shelf level

Add-On Units

- 2 Standard Tee Posts (Up to and including 144" high)
- 2 Double Rivet Angle Beams left to right per shelf level
- 2 Double Rivet Angle Beams front to back per shelf level

- Order Deck Material Separately -

Double Rivet Units (w/o Center Support)

4 Shelf Starter Unit, 48" Wide

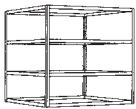

48	18	84	R	46001H	180.00	Unit	59.2
48	24	84	R	46002H	184.80	Unit	62.4
48	30	84	R	46003H	190.40	Unit	65.6
48	36	84	R	46004H	201.20	Unit	68.0
48	48	84	R	46005H	219.60	Unit	80.0

4 Shelf Starter Unit, 60" Wide

60	18	84	R	46011H	194.00	Unit	66.4
60	24	84	R	46012H	198.80	Unit	69.6
60	30	84	R	46013H	204.40	Unit	72.8
60	36	84	R	46014H	215.20	Unit	75.2
60	48	84	R	46015H	233.60	Unit	87.2

4 Shelf Starter Unit, 72" Wide

72	18	84	R	46021H	211.60	Unit	74.4
72	24	84	R	46022H	216.40	Unit	77.6
72	30	84	R	46023H	222.00	Unit	80.8
72	36	84	R	46024H	232.80	Unit	83.2
72	48	84	R	46025H	251.20	Unit	95.2

4 Shelf Add-On Unit, 48" Wide

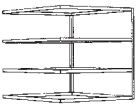

48	18	84	R	46006H	172.30	Unit	57.2
48	24	84	R	46007H	177.10	Unit	60.4
48	30	84	R	46008H	182.70	Unit	63.6
48	36	84	R	46009H	193.50	Unit	66.0
48	48	84	R	46010H	211.90	Unit	78.0

4 Shelf Add-On Unit, 60" Wide

60	18	84	R	46016H	186.30	Unit	64.4
60	24	84	R	46017H	191.10	Unit	67.6
60	30	84	R	46018H	196.70	Unit	70.8
60	36	84	R	46019H	207.50	Unit	73.2
60	48	84	R	46020H	225.90	Unit	85.2

4 Shelf Add-On Unit, 72" Wide

72	18	84	R	46026H	203.90	Unit	72.4
72	24	84	R	46027H	208.70	Unit	75.6
72	30	84	R	46028H	214.30	Unit	78.8
72	36	84	R	46029H	225.10	Unit	81.2
72	48	84	R	46030H	243.50	Unit	93.2

5 Shelf Starter Unit, 72" Wide

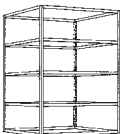

72	30	120	R	46041H	287.00	Unit	104.2
72	36	120	R	46042H	300.70	Unit	107.2
72	48	120	R	46043H	323.70	Unit	122.2

5 Shelf Add-On Unit, 72" Wide

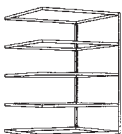

72	30	120	R	46044H	274.10	Unit	101.6
72	36	120	R	46045H	287.60	Unit	104.6
72	48	120	R	46046H	310.60	Unit	119.6

* NOTES: Traditional Color is 723 Light Putty, however all standard colors are available. Color selection must be made on the order. All Unit Catalog Numbers are for Steel Framing only. Order deck material separately.

W	D	H	*	Cat. No.	Price	Per	Wt.	Pkg.
---	---	---	---	----------	-------	-----	-----	------

Double Rivet Units with Center Supports Consist of:

Starter Units

- 4 Standard Angle Posts (Up to and including 144" high)
- 2 Double Rivet Angle Beams left to right per shelf level
- 2 Double Rivet Angle Beams front to back per shelf level
- 1 Center Support per shelf level except for 96" wide units which have 2 per level.

Add-On Units

- 2 Standard Tee Posts (Up to and including 144" high)
- 2 Double Rivet Angle Beams left to right per shelf level
- 2 Double Rivet Angle Beams front to back per shelf level
- 1 Center Support per shelf level except for 96" wide units which have 2 per level.

- Order Deck Material Separately -

Double Rivet Units (w/Center Support)

4 Shelf Starter Unit, 48" Wide



48	18	84	R	46W01H	206.80	Unit	64.8
48	24	84	R	46W02H	215.60	Unit	69.6
48	30	84	R	46W03H	224.80	Unit	74.4
48	36	84	R	46W04H	238.40	Unit	78.8
48	48	84	R	46W05H	268.40	Unit	94.0

4 Shelf Starter Unit, 60" Wide

60	18	84	R	46W11H	220.80	Unit	72.0
60	24	84	R	46W12H	229.60	Unit	76.8
60	30	84	R	46W13H	238.80	Unit	81.6
60	36	84	R	46W14H	252.40	Unit	86.0
60	48	84	R	46W15H	282.40	Unit	101.2

60	18	84	C	46W01C	245.40	Unit	79.8
60	24	84	C	46W02C	254.20	Unit	84.6
60	30	84	C	46W03C	263.40	Unit	89.4
60	36	84	C	46W04C	277.00	Unit	93.8
60	48	84	C	46W05C	307.00	Unit	109.0

4 Shelf Starter Unit, 72" Wide

72	18	84	R	46W21H	238.40	Unit	80.0
72	24	84	R	46W22H	247.20	Unit	84.8
72	30	84	R	46W23H	256.40	Unit	89.6
72	36	84	R	46W24H	270.00	Unit	94.0
72	48	84	R	46W25H	300.00	Unit	109.2

72	18	84	C	46W11C	263.30	Unit	89.0
72	24	84	C	46W12C	272.10	Unit	93.8
72	30	84	C	46W13C	281.30	Unit	98.6
72	36	84	C	46W14C	294.90	Unit	103.0
72	48	84	C	46W15C	324.90	Unit	118.2

4 Shelf Starter Unit, 96" Wide

96	18	84	R	46W31H	300.40	Unit	100.0
96	24	84	R	46W32H	313.20	Unit	106.4
96	30	84	R	46W33H	326.00	Unit	112.8
96	36	84	R	46W34H	342.40	Unit	119.2
96	48	84	R	46W35H	384.00	Unit	137.6

96	18	84	C	46W21C	335.80	Unit	112.6
96	24	84	C	46W22C	348.60	Unit	119.0
96	30	84	C	46W23C	361.40	Unit	125.4
96	36	84	C	46W24C	377.80	Unit	131.8
96	48	84	C	46W25C	419.40	Unit	150.2

C: Uses Channel Beam (except at floor level).

R: Beams 48" or longer are Heavy Duty, all other units have standard beams.



RivetRite Double Rivet Units

W	D	H	*	Cat. No.	Price	Per	Wt.	Pkg.
---	---	---	---	----------	-------	-----	-----	------

4 Shelf Add-On Unit, 48" Wide

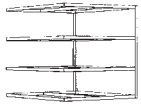

48	18	84	R	46W06H	199.10	Unit	62.8	
48	24	84	R	46W07H	207.90	Unit	67.6	
48	30	84	R	46W08H	217.10	Unit	72.4	
48	36	84	R	46W09H	230.70	Unit	76.8	
48	48	84	R	46W10H	260.70	Unit	92.0	

4 Shelf Add-On Unit, 60" Wide

60	18	84	R	46W16H	213.10	Unit	70.0	
60	24	84	R	46W17H	221.90	Unit	74.8	
60	30	84	R	46W18H	231.10	Unit	79.6	
60	36	84	R	46W19H	244.70	Unit	84.0	
60	48	84	R	46W20H	274.70	Unit	99.2	
60	18	84	C	46W06C	237.70	Unit	77.8	
60	24	84	C	46W07C	246.50	Unit	82.6	
60	30	84	C	46W08C	255.70	Unit	87.4	
60	36	84	C	46W09C	269.30	Unit	91.8	
60	48	84	C	46W10C	299.30	Unit	107.0	

4 Shelf Add-On Unit, 72" Wide

72	18	84	R	46W26H	230.70	Unit	78.0	
72	24	84	R	46W27H	239.50	Unit	82.8	
72	30	84	R	46W28H	248.70	Unit	87.6	
72	36	84	R	46W29H	262.30	Unit	92.0	
72	48	84	R	46W30H	292.30	Unit	107.2	
72	18	84	C	46W16C	255.60	Unit	87.0	
72	24	84	C	46W17C	264.40	Unit	91.8	
72	30	84	C	46W18C	273.60	Unit	96.6	
72	36	84	C	46W19C	287.20	Unit	101.0	
72	48	84	C	46W20C	317.20	Unit	116.2	

4 Shelf Add-On Unit, 96" Wide

96	18	84	R	46W36H	292.70	Unit	98.0	
96	24	84	R	46W37H	305.50	Unit	104.4	
96	30	84	R	46W38H	318.30	Unit	110.8	
96	36	84	R	46W39H	334.70	Unit	117.2	
96	48	84	R	46W40H	376.30	Unit	135.6	
96	18	84	C	46W26C	328.10	Unit	110.6	
96	24	84	C	46W27C	340.90	Unit	117.0	
96	30	84	C	46W28C	353.70	Unit	123.4	
96	36	84	C	46W29C	370.10	Unit	129.8	
96	48	84	C	46W30C	411.70	Unit	148.2	

W	D	H	*	Cat. No.	Price	Per	Wt.	Pkg.
---	---	---	---	----------	-------	-----	-----	------

5 Shelf Starter Unit, 72" Wide

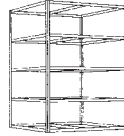

72	30	120	R	46W41H	330.20	Unit	115.2	
72	36	120	R	46W42H	347.20	Unit	120.7	
72	48	120	R	46W43H	384.70	Unit	139.7	
72	30	120	C	46W31C	363.40	Unit	127.2	
72	36	120	C	46W32C	380.40	Unit	132.7	
72	48	120	C	46W33C	417.90	Unit	151.7	

5 Shelf Starter Unit, 96" Wide

96	30	120	R	46W47H	417.20	Unit	144.2	
96	36	120	R	46W48H	437.70	Unit	152.2	
96	48	120	R	46W49H	489.70	Unit	175.2	
96	30	120	C	46W37C	464.40	Unit	161.0	
96	36	120	C	46W38C	484.90	Unit	169.0	
96	48	120	C	46W39C	536.90	Unit	192.0	

5 Shelf Add-On Unit, 72" Wide



72	30	120	R	46W44H	317.10	Unit	112.6	
72	36	120	R	46W45H	334.10	Unit	118.1	
72	48	120	R	46W46H	371.60	Unit	137.1	
72	30	120	C	46W34C	350.30	Unit	124.6	
72	36	120	C	46W35C	367.30	Unit	130.1	
72	48	120	C	46W36C	404.80	Unit	149.1	

5 Shelf Add-On Unit, 96" Wide

96	30	120	R	46W50H	404.10	Unit	141.6	
96	36	120	R	46W51H	424.60	Unit	149.6	
96	48	120	R	46W52H	476.60	Unit	172.6	
96	30	120	C	46W40C	451.30	Unit	158.4	
96	36	120	C	46W41C	471.80	Unit	166.4	
96	48	120	C	46W42C	523.80	Unit	189.4	

C: Uses Channel Beam (except at floor level).
R: Beams 48" or longer are Heavy Duty, all other units have standard beams.

* NOTES: Traditional Color is 723 Light Putty, however all standard colors are available. Color selection must be made on the order.
All Unit Catalog Numbers are for Steel Framing only. Order deck material separately.

Single Rivet Shelving Units



W	D	H	*	Cat. No.	Price	Per	Wt.	Pkg.
---	---	---	---	----------	-------	-----	-----	------

W	D	H	*	Cat. No.	Price	Per	Wt.	Pkg.
---	---	---	---	----------	-------	-----	-----	------

Single Rivet Units Consist of:

Starter Units

- 4 Standard Angle Posts
- 4 Double Rivet Angle Beams left to right
- 4 Double Rivet Angle Beams front to back
- The appropriate number of Single Rivet Shelf Beams left to right.
- 2 Single Rivet Shelf Beams front to back up to 24" deep;

All units that are 36" Deep - Single Rivet Shelf Beams front to back at every shelf level

Add-On Units

- 2 Standard Tee Posts
- 2 Standard Angle Posts
- 4 Double Rivet Angle Beams left to right
- 2 Double Rivet Angle Beams front to back, except 36" deep unit has 4. The appropriate number of Single Rivet Shelf Beams left to right.
- 1 Single Rivet Shelf Beam front to back except for 36" deep which has 2 per shelf level.

- Order Deck Material Separately -

Single Rivet Unit Capacities

Inches			Number of Shelf levels per Unit	Capacity ** (lbs.)
Width	Depth	Height		
36	12 - 36	84	5 - 8	350
48	12 - 36	84	5 - 8	250

**Capacities are for the steel beam levels, not the shelf deck material. They are expressed in pounds for uniformly distributed loads.

Single Rivet Shelving Units

5 Shelf Starter Unit

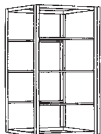

36	12	84	461315	142.10	Unit	42.4
36	18	84	461325	147.30	Unit	44.6
36	24	84	461335	150.40	Unit	46.6
36	36	84	461345	181.00	Unit	56.8
48	12	84	461415	155.20	Unit	51.4
48	18	84	461425	157.20	Unit	52.0
48	24	84	461435	163.50	Unit	55.6
48	36	84	461445	194.10	Unit	65.8

5 Shelf Add-On Unit



36	12	84	462355	134.40	Unit	40.4
36	18	84	462365	139.60	Unit	42.6
36	24	84	462375	142.70	Unit	44.6
36	36	84	462385	173.30	Unit	54.8
48	12	84	462455	147.50	Unit	49.4
48	18	84	462465	149.50	Unit	50.0
48	24	84	462475	155.80	Unit	53.6
48	36	84	462485	186.40	Unit	63.8

6 Shelf Starter Unit



36	12	84	461316	152.00	Unit	45.6
36	18	84	461326	157.20	Unit	47.8
36	24	84	461336	160.30	Unit	49.8
36	36	84	461346	200.80	Unit	63.2
48	12	84	461416	166.40	Unit	55.6
48	18	84	461426	171.60	Unit	57.8
48	24	84	461436	174.70	Unit	59.8
48	36	84	461446	215.20	Unit	73.2

6 Shelf Add-On Unit



36	12	84	462356	144.30	Unit	43.6
36	18	84	462366	149.50	Unit	45.8
36	24	84	462376	152.60	Unit	47.8
36	36	84	462386	193.10	Unit	61.2
48	12	84	462456	158.70	Unit	53.6
48	18	84	462466	163.90	Unit	55.8
48	24	84	462476	167.00	Unit	57.8
48	36	84	462486	207.50	Unit	71.2

7 Shelf Starter Unit



36	12	84	461317	161.90	Unit	48.8
36	18	84	461327	167.10	Unit	51.0
36	24	84	461337	170.20	Unit	53.0
36	36	84	461347	220.60	Unit	69.6
48	12	84	461417	177.60	Unit	59.8
48	18	84	461427	179.60	Unit	60.4
48	24	84	461437	185.90	Unit	64.0
48	36	84	461447	236.30	Unit	80.6

7 Shelf Add-On Unit



36	12	84	462357	154.20	Unit	46.8
36	18	84	462367	159.40	Unit	49.0
36	24	84	462377	162.50	Unit	51.0
36	36	84	462387	212.90	Unit	67.6
48	12	84	462457	169.90	Unit	57.8
48	18	84	462467	171.90	Unit	58.4
48	24	84	462477	178.20	Unit	62.0
48	36	84	462487	228.60	Unit	78.6

8 Shelf Starter Unit



36	12	84	461318	171.80	Unit	52.0
36	18	84	461328	177.00	Unit	54.2
36	24	84	461338	180.10	Unit	56.2
36	36	84	461348	240.40	Unit	76.0
48	12	84	461418	188.80	Unit	64.0
48	18	84	461428	190.80	Unit	64.6
48	24	84	461438	197.10	Unit	68.2
48	36	84	461448	257.40	Unit	88.0

8 Shelf Add-On Unit



36	12	84	462358	164.10	Unit	50.0
36	18	84	462368	169.30	Unit	52.2
36	24	84	462378	172.40	Unit	54.2
36	36	84	462388	232.70	Unit	74.0
48	12	84	462458	181.10	Unit	62.0
48	18	84	462468	186.30	Unit	64.2
48	24	84	462478	189.40	Unit	66.2
48	36	84	462488	239.80	Unit	82.8

* NOTES: Traditional Color is 723 Light Putty, however all standard colors are available. Color selection must be made on the order.

All Unit Catalog Numbers are for Steel Framing only. Order deck material separately.



RivetRite Record Storage Units

W	D	H	*	Cat. No.	Price	Per	Wt.	Pkg.
---	---	---	---	----------	-------	-----	-----	------

W	D	H	*	Cat. No.	Price	Per	Wt.	Pkg.
---	---	---	---	----------	-------	-----	-----	------

Units with 4 levels are illustrated.
Actual number of shelf levels shown in table at right
 (60"=3; 84"=4; 108"=5; 168"=7; 192"=8 levels).

Record Storage Shelving Units

Order Deck Material Separately.

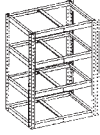

For Use With Decking

Starter Units							
42	15	84	46601A	165.20	Unit	48.8	
42	30	84	46602A	178.40	Unit	56.8	
69	15	84	46603A	203.60	Unit	70.4	
69	30	84	46604A	251.20	Unit	87.2	
42	15	108	46605A	208.00	Unit	61.4	
42	30	108	46606A	224.50	Unit	71.4	
69	15	108	46607A	256.00	Unit	88.4	
69	30	108	46608A	315.50	Unit	109.4	
69	15	168	46609A	393.60	Unit	136.0	
69	30	168	46610A	476.90	Unit	165.4	
69	15	192	46611A	449.40	Unit	155.6	
69	30	192	46612A	544.60	Unit	189.2	

Order Deck Material Separately.

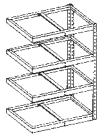

Add-On Units							
42	15	84	46613A	157.50	Unit	46.8	
42	30	84	46614A	170.70	Unit	54.8	
69	15	84	46615A	195.90	Unit	68.4	
69	30	84	46616A	243.50	Unit	85.2	
42	15	108	46617A	195.20	Unit	59.2	
42	30	108	46618A	211.70	Unit	69.2	
69	15	108	46619A	243.20	Unit	86.2	
69	30	108	46620A	302.70	Unit	107.2	
69	15	168	46621A	399.30	Unit	134.6	
69	30	168	46622A	482.60	Unit	164.0	
69	15	192	46623A	456.40	Unit	153.8	
69	30	192	46624A	551.60	Unit	187.4	

With Steel Box Supports

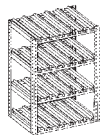

Starter Units							
42	15	60	46701A	216.90	Unit	50.2	
42	30	60	46702A	272.70	Unit	67.0	
69	15	60	46703A	310.50	Unit	76.0	
69	30	60	46704A	422.70	Unit	106.6	
42	15	84	46705A	292.00	Unit	68.0	
42	30	84	46706A	366.40	Unit	90.4	
69	15	84	46707A	416.80	Unit	102.4	
69	30	84	46708A	566.40	Unit	143.2	

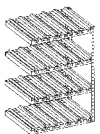

Add-On Units							
42	15	60	46709A	212.90	Unit	49.0	
42	30	60	46710A	268.70	Unit	65.8	
69	15	60	46711A	306.50	Unit	74.8	
69	30	60	46712A	418.70	Unit	105.4	
42	15	84	46713A	284.30	Unit	66.0	
42	30	84	46714A	358.70	Unit	88.4	
69	15	84	46715A	409.10	Unit	100.4	
69	30	84	46716A	558.70	Unit	141.2	

Record Storage Unit Storage Box Capacities				
Inches			Number of Shelves	Number of Boxes
Width	Depth	Height		
42	15	60	3	18
42	30	60	3	36
69	15	60	3	30
69	30	60	3	60
42	15	84	4	24
42	30	84	4	48
69	15	84	4	40
69	30	84	4	80
42	15	108	5	30
42	30	108	5	60
69	15	108	5	50
69	30	108	5	100
69	15	168	7	70
69	30	168	7	140
69	15	192	8	80
69	30	192	8	160

Box capacities are based on a standard archive box size of 12-1/2" w x 16 1/2" d x 10-1/2" h

The unit illustrations to the left show starter units as if they were the beginning of a continuous row, where a Tee Post would be common between units. If you are ordering a single starter unit, you will receive all Angle Posts. Tee Posts are furnished with Add-On units.

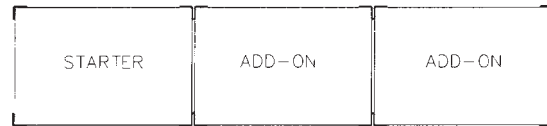

Record Storage Units For Use With Decking Consist of:

Starter Units

- 4 Standard Angle Posts (Up to and including 108" high) 168" and 192" are Heavy Duty
- 2 Double Rivet Angle Beams left to right per shelf level
- 2 Double Rivet Angle Beams front to back per shelf level
- 1 Center Support per shelf level for 69" w. x 30" d. only.

Add-On Units

- 2 Standard Tee Posts (Up to and including 108" high) 168" and 192" are Heavy Duty
- 2 Double Rivet Angle Beams left to right per shelf level
- 2 Double Rivet Angle Beams front to back per shelf level
- 1 Center Support per shelf level for 69" w. x 30" d. only.

Record Storage Units For Use With Steel Box Supports Consist of:

Same as above with the addition of Steel Box Supports in the following quantities.

- 3 pair per 42" wide shelf level
- 5 pair per 69" wide shelf level

* NOTES: Traditional Color is 723 Light Putty, however all standard colors are available. Color selection must be made on the order.

All Unit Catalog Numbers are for Steel Framing only. Order deck material separately.

W	D	H	*	Cat. No.	Price	Per	Wt.	Pkg.
---	---	---	---	----------	-------	-----	-----	------

Tire Storage Racks (for 'standard' tires)

Single-Row, (12" deep units with 9" Wall Ties) and Double-Row, (two 12" deep units separated by 18" Double Row Spacers). Unit depth shown includes wall ties/row spacers. 192" high units are supplied with Heavy Duty Posts.

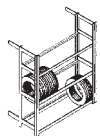

Single Row Starter Units

60	21	84		46351T	185.40	Unit	57.0
60	21	120		46352T	242.00	Unit	76.0
60	21	144		46353T	292.80	Unit	92.6
60	21	192		46354T	383.40	Unit	124.0

Single Row Add-On Units

60	21	84		46451T	150.30	Unit	50.2
60	21	120		46452T	218.30	Unit	71.8
60	21	144		46453T	264.60	Unit	87.6
60	21	192		46454T	379.80	Unit	120.6

Double Row Starter Units

60	42	84		46355T	355.60	Unit	113.2
60	42	120		46356T	468.80	Unit	151.2
60	42	144		46357T	570.40	Unit	184.4
60	42	192		46358T	751.60	Unit	247.2

Double Row Add-On Units

60	42	84		46455T	293.00	Unit	100.0
60	42	120		46456T	387.00	Unit	135.2
60	42	144		46457T	471.20	Unit	165.2
60	42	192		46458T	693.20	Unit	229.6

Tire Storage Racks (SUV Tires)

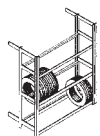

Single Row Starter Units

Accommodates Larger SUV Tires. Single-Row, (15" deep units with 9" Wall Ties) and Double-Row, (two 15" deep units separated by 18" Double Row Spacers) configurations. Unit depth shown includes wall ties/row spacers. 192" high units are supplied with Heavy Duty Posts.

60	24	84		46361TP	189.00	Unit	58.6
60	24	120		46362TP	246.50	Unit	78.0
60	24	144		46363TP	298.20	Unit	95.0
60	24	192		46364TP	389.70	Unit	126.8

Single Row Add-On Units

60	24	84		46461TP	152.10	Unit	51.0
60	24	120		46462TP	199.55	Unit	68.8
60	24	144		46463TP	242.10	Unit	84.0
60	24	192		46464TP	353.55	Unit	116.4

Double Row Starter Units

60	48	84		46655TP	362.80	Unit	116.4
60	48	120		46656TP	477.80	Unit	155.2
60	48	144		46657TP	581.20	Unit	189.2
60	48	192		46658TP	764.20	Unit	252.8

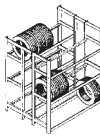

W	D	H	*	Cat. No.	Price	Per	Wt.	Pkg.
---	---	---	---	----------	-------	-----	-----	------

Double Row Add-On Units

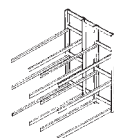

60	48	84		46665TP	296.60	Unit	101.6
60	48	120		46456TP	391.50	Unit	137.2
60	48	144		46557TP	476.60	Unit	167.6
60	48	192		46558TP	699.50	Unit	232.4

Muffler Storage

Order Deck Material Separately.

5 Shelf Starter Units



48	36	84		46801M	236.40	Unit	80.2
96	36	84		46802M	412.90	Unit	144.2

5 Shelf Add-On Units



48	36	84		46803M	228.70	Unit	78.2
96	36	84		46804M	405.20	Unit	142.2

Tire Storage Rack Unit Tire Capacities

Width	Inches		Number of Tiers	Tire Capacity
	Depth	Height		
Single Row Tire Racks				
60	21	84	3	24
60	21	120	4	32
60	21	144	5	40
60	21	192	6	48
Double Row Tire Racks				
60	42	84	3	48
60	42	120	4	64
60	42	144	5	80
60	42	192	6	96
Tire storage capacities are based on an average passenger size tire.				

Hanging Tailpipe Rack

Designed specifically for the storage of automotive and light truck tailpipes. Stored items are visible and easily accessible.

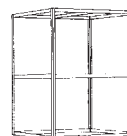

Starter Unit Only

48	18	120		46901P	188.30	Unit	60.0
96	18	120		46902P	265.20	Unit	87.8

* NOTES: Traditional Color is 723 Light Putty, however all standard colors are available. Color selection must be made on the order.

All Unit Catalog Numbers are for Steel Framing only. Order deck material separately.

W	D	H	*	Cat. No.	Price	Per	Wt.	Pkg.
---	---	---	---	----------	-------	-----	-----	------

W	D	H	*	Cat. No.	Price	Per	Wt.	Pkg.
---	---	---	---	----------	-------	-----	-----	------

How To Order RivetRite COMPONENTS

These pages contain the component parts used to build all RivetRite units. Before designing RivetRite for a specific application, determine the following:

1. The desired shelf size and capacity.
2. The required number of shelves and the spacing between shelves.
3. The post height and capacity needed to support the shelves.
4. The type and capacity of decking material to be used.

Once these decisions have been made, you can select the parts:

5. Select left to right beams and center supports (if required) to carry the load. See Beam Load Tables for capacities. Note that all units require Double Rivet Beams from left to right and from front to back at the top and bottom. Refer to "Design Criteria" and Particle Board Load Chart.

6. Add front to back beams as required. See "Design Criteria".

7. Add the appropriate size, type and quantity and capacity of posts for the application. Check the post capacity by multiplying the number of shelves x average load per shelf. Divide by 4 for Angle Posts; divide by 2 for TEE Posts, then refer to the chart. Determine the largest distance between beams. Check both the left to right and front to back dimension and use the largest distance. Check the capacity by using the appropriate Post Capacity Chart.

8. Add the appropriately sized deck material. Verify that the deck will hold the load (see capacity chart for 5/8" particle board).

9. Double check to see that all beams, deck material and posts have sufficient capacity to hold the anticipated load.

(For information on shelving growth and shelf spacing, refer to the 'Storage Products' catalog).

Angle Posts (Punched on 1-1/2" centers)



Standard, 1-1/2" x 1-1/2"

36	46AS03C	6.45	Ea.	2.1
48	46AS04C	8.55	Ea.	2.8
60	46AS05C	10.80	Ea.	3.4
72	46AS06C	12.85	Ea.	4.1
84	46AS07C	15.10	Ea.	4.8
96	46AS08C	17.00	Ea.	5.5
108	46AS09C	19.25	Ea.	6.1
120	46AS10C	21.30	Ea.	6.8
144	46AS12C	26.05	Ea.	8.2



Heavy Duty, 1-7/8" x 1-7/8"

96	46AH08C	20.15	Ea.	6.7
108	46AH09C	23.35	Ea.	7.5
120	46AH10C	25.80	Ea.	8.3
144	46AH12C	30.75	Ea.	10.1
168	46AH14C	35.75	Ea.	11.6
192	46AH16C	40.75	Ea.	13.3
216	46AH18C	45.65	Ea.	14.9

Tee Posts (Punched on 1-1/2" centers)



Standard, 3" x 1-1/2"

36	46TS03C	12.80	Ea.	3.8
48	46TS04C	16.30	Ea.	5.0
60	46TS05C	19.60	Ea.	6.2
72	46TS06C	22.85	Ea.	7.4
84	46TS07C	26.35	Ea.	8.6
96	46TS08C	29.70	Ea.	9.9
108	46TS09C	32.10	Ea.	11.1
120	46TS10C	36.05	Ea.	12.3
144	46TS12C	43.30	Ea.	14.7



Heavy Duty, 3-3/4" x 1-7/8"

84	46TH07C	36.60	Ea.	11.3
96	46TH08C	41.40	Ea.	12.9
108	46TH09C	44.80	Ea.	14.5
120	46TH10C	49.15	Ea.	16.1
144	46TH12C	58.55	Ea.	19.3
168	46TH14C	74.35	Ea.	22.5
192	46TH16C	85.00	Ea.	25.7
216	46TH18C	95.40	Ea.	29.0

Post Splice

Used to extend post; attaches to outside of post. Order one per Angle Post, two per Tee Post.



1-3/8	1-3/8	5	46PS0H	4.70	Ea.	0.5
-------	-------	---	--------	------	-----	-----

RivetRite Post Capacity Chart

Recommended safe loads (per post) for use only where seismic forces are not a factor.

Beam Spacing (inches)	Standard Angle Post Capacity (lbs.)	Heavy Duty Angle Post Capacity (lbs.)
12	1530	1735
18	1520	1720
24	1510	1695
30	1490	1680
36	1350	1660
42	990	1560
48	755	1195

Beam Spacing (inches)	Standard Tee Post Capacity (lbs.)	Heavy Duty Tee Post Capacity (lbs.)
12	4725	5045
18	4510	4965
24	4210	4850
30	3825	4705
36	3350	4525
42	2795	4315
48	2180	4075

For beam spacing over 48", please contact Penco.

Post capacities are based on the maximum vertical distance between left to right beams or front to back beams, whichever is greater. In single rivet beam units, the vertical distance between front to back beams will usually govern.

Tie plates must be spaced no more than 48 inches apart to insure structural stability when joining angle posts together.

The above capacities are NOT intended for use when designing multi-level systems or for specific requirements where seismic forces are a factor. For specific multi-level or seismic requirements, contact your Penco District Manager.

W	D	H	*	Cat. No.	Price	Per	Wt.	Pkg.
---	---	---	---	----------	-------	-----	-----	------

Single Rivet Shelf Beams

For use as left to right and front to back shelf support. See Beam Load Table for capacity. Do not mix with any other beam type on the same level. You MUST fully frame each unit with DOUBLE Rivet beams at the top and bottom.

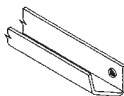
Standard								
	12	1		46SS12C	2.30	Ea.	0.6	
	15	1		46SS15C	3.15	Ea.	0.7	
	18	1		46SS18C	3.30	Ea.	0.9	
	24	1		46SS24C	3.65	Ea.	1.1	
	30	1		46SS30C	4.20	Ea.	1.3	
	36	1		46SS36C	4.95	Ea.	1.6	
	42	1		46SS42C	5.35	Ea.	1.9	
	48	1		46SS48C	5.60	Ea.	2.1	

Heavy Duty

Heavy duty 36" support beam capacity is 600 lbs. per pair. Heavy duty 48" support beam capacity is 500 lbs. per pair.

	36	1-1/4		46HS36C	7.15	Ea.	3.2	
	42	1-1/4		46HS42C	8.00	Ea.	3.7	
	48	1-1/4		46HS48C	8.95	Ea.	4.2	

Double Rivet Angle Beams

2-3/4" h. x 1" d. - For left to right and front to back shelf support. NOTE: "S" is for beams punched to accept Record Storage Box Supports.

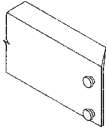
Standard								
	12			46SB12C	4.20	Ea.	0.8	
	15			46SB15C	4.65	Ea.	1.0	
	18			46SB18C	5.00	Ea.	1.2	
	24			46SB24C	5.60	Ea.	1.6	
	30			46SB30C	6.30	Ea.	2.0	
	32			46SB32C	7.00	Ea.	2.2	
	36			46SB36C	7.65	Ea.	2.3	
	42			46SB42C	8.45	Ea.	2.7	
	42		S	46AB42C	9.45	Ea.	2.7	

Heavy Duty

	48			46HB48C	9.95	Ea.	3.8	
	60			46HB60C	11.70	Ea.	4.7	
	69			46HB69C	13.25	Ea.	5.4	
	69		S	46AB69C	15.15	Ea.	5.4	
	72			46HB72C	13.90	Ea.	5.7	
	84			46HB84C	15.95	Ea.	6.6	
	96			46HB96C	18.30	Ea.	7.5	

Double Rivet Channel Beams

3"h. x 1"d. - For left to right shelf support. Provides for a higher capacity than Heavy Duty Double Rivet Angle Beams. NOTE: When a bottom shelf is required to be at the bottom level, use a Heavy Duty Double Rivet Angle Beam.

	60			46CB60C	15.80	Ea.	6.0	
	69			46CB69C	17.75	Ea.	7.0	
	72			46CB72C	18.05	Ea.	7.2	
	84			46CB84C	21.30	Ea.	8.4	
	96			46CB96C	24.20	Ea.	9.6	

W	D	H	*	Cat. No.	Price	Per	Wt.	Pkg.
---	---	---	---	----------	-------	-----	-----	------

RivetRite Beam Capacities

Recommended Safe Use Allowable
Uniformly Distributed Hand Loaded Static Beam Loads

Width (in.)	Cap./Pair (lbs.)	Deflection (in.)
Single Rivet Shelf Beams		
Standard Beams		
36	350	0.25
42	300	0.30
48	250	0.34
Heavy Duty Beams		
36	600	0.25
42	550	0.30
48	500	0.34
Double Rivet Angle Beams		
Standard Beams		
Without Center Supports (***)		
36	1000	***
42	780	***
Heavy Duty Beams		
Without Center Supports (***)		
48	750	***
60	600	***
69	525	***
72	500	***
With Center Supports (*)		
48	1400	0.16
60	1200	0.25
69	1050	0.33
72	1000	0.36
84	840	0.49
96	620	0.53
Double Rivet Channel Beams		
With Center Supports (*)		
60	2240	0.23
72	1850	0.33
84	1600	0.45
96	1400	0.59
Double Rivet Zee Step Beams		
Without Center Supports		
48	1250	-
60	750	-
69	600	-
72	600	-
With Center Supports (*)		
48	1750	
60	1000	
69	1000	
72	1000	

(*) One (1) support per pair of beams except 96" which have two (2) Supports

(***) Beam rotation is less than 5 degrees

* S: Beam is punched to accept Record Storage Box Supports.

W	D	H	*	Cat. No.	Price	Per	Wt.	Pkg.
---	---	---	---	----------	-------	-----	-----	------

W	D	H	*	Cat. No.	Price	Per	Wt.	Pkg.
---	---	---	---	----------	-------	-----	-----	------

Center Supports

2-3/4" h. - Bolts to double rivet or channel beams to add support to decking and stabilize beams. Supplied with bolts and wing nuts for fast assembly. Use 1 per pair of beams under 96"; 2 per pair of 96" beams.

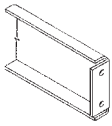

12		46CS12	5.70	Ea.	1.0
15		46CS15	6.25	Ea.	1.2
18		46CS18	6.70	Ea.	1.4
24		46CS24	7.70	Ea.	1.8
30		46CS30	8.60	Ea.	2.2
32		46CS32	9.10	Ea.	2.4
36		46CS36	9.30	Ea.	2.7
42		46CS42	10.70	Ea.	3.1
48		46CS48	12.20	Ea.	3.5

Double Rivet Zee Step Beams

2-1/8" h. - For left to right and front to back shelf support. Lower profile than other double rivet beams allows more useable space between shelf levels.

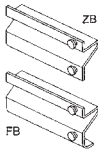

ZB Style Beam

12	-	-	46ZB12C	4.05	Ea.	0.9
15	-	-	46ZB15C	4.60	Ea.	1.1
18	-	-	46ZB18C	5.45	Ea.	1.3
24	-	-	46ZB24C	6.65	Ea.	1.8
30	-	-	46ZB30C	7.75	Ea.	2.2
32	-	-	46ZB32C	8.35	Ea.	2.4
36	-	-	46ZB36C	9.05	Ea.	2.7
42	-	-	46ZB42C	10.20	Ea.	3.1
48	-	-	46ZB48C	11.30	Ea.	3.5
60	-	-	46ZB60C	13.65	Ea.	4.4

FB Style Beam

69	-	-	46FB69C	17.40	Ea.	5.6
72	-	-	46FB72C	17.90	Ea.	5.8

Decking Support For Zee Beams

1-1/8" h. - 11 Gauge. Provides front to back support for decking when used with Zee Step Beams.

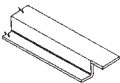

-	24	-	46ZS24C	5.60	Ea.	2.2
-	30	-	46ZS30C	6.50	Ea.	2.8
-	32	-	46ZS32C	6.90	Ea.	3.0
-	36	-	46ZS36C	7.50	Ea.	3.3
-	42	-	46ZS42C	8.45	Ea.	3.9
-	48	-	46ZS48C	9.55	Ea.	4.4

Double Rivet Low-Profile Beams

Intended for use with deck material with minimum thickness of 1/2". Do not mix with any other beam type on the same level. Center supports are NOT available. Can be used at top and bottom of unit.



12		46DB12C	3.40	Ea.	0.4
15		46DB15C	3.50	Ea.	0.6
18		46DB18C	3.75	Ea.	0.7
24		46DB24C	4.45	Ea.	0.9
30		46DB30C	5.20	Ea.	1.2
32		46DB32C	5.40	Ea.	1.3
36		46DB36C	5.85	Ea.	1.4
42		46DB42C	6.45	Ea.	1.7
48		46DB48C	6.75	Ea.	2.0

Low Profile

Double Rivet Beam Capacities

With 5/8" Particle Board Decking, (All 4 Sides Supported)

Shelf Size W x D (in.)	Capacity (lbs.)**
36x12	193
36x15	203
36x18	212
36x24	231
36x30	255
36x32	266
36x36	293
42X12	166
42X15	168
42X18	170
42X24	176
42X30	187
42X32	192
42X36	204
48x12	136
48x15	136
48x18	136
48x24	138
48x30	143
48x32	145
48x36	150
48x42	162
48x48	181

The Low-Profile RivetRite Beam capacities shown here are for all four sides of a shelf deck supported (front and rear, and both sides). All loading calculations are based upon ANSI standard MH 28.2-1996 (L/140)**. The allowable loads shown are uniformly distributed and assume 5/8" thick particle board is the shelf deck material.

Other decking material, such as plywood or steel, may change unit load capacities. For special sizes not listed here, please direct your inquiries to the Shelving Product Managers and include as much detail about the proposed installation as possible.

* Capacities shown are for Evenly Distributed Loads
 ** L = Length

Tire Rack Beams

2-3/4" h. - For left to right support of tires. 30 degree angle on supporting edge.



48	46TB48C	10.35	Ea.	3.8
60	46TB60C	11.70	Ea.	4.7

Wall Ties

Used to secure units to wall and provide space between wall and unit. (Hardware to attach to wall not included.)



9-1/4	46WT09C	5.30	Ea.	0.8
-------	----------------	-------------	-----	-----

W	D	H	*	Cat. No.	Price	Per	Wt.	Pkg.
---	---	---	---	----------	-------	-----	-----	------

Double Row And Top Ties

Used to space back-to-back units and to top-tie rows across aisles for added stability.

	9-1/4			46RT09C	5.40	Ea.	0.8	
	15-1/4			46RT15C	6.30	Ea.	1.2	
	18-1/4			46RT18C	6.80	Ea.	1.4	
	36-1/4			46RT36C	8.85	Ea.	2.5	

Foot Plate

For use in anchoring angle and tee posts to the floor. Hardware included for attaching to posts. Floor anchor holes are 1/2" diameter. Hardware to anchor to the floor not included - see No. 9280, Concrete Floor Anchor in Wide Span Section.

	4			46FP0H	3.50	Ea.	0.5	
---	---	--	--	---------------	-------------	-----	-----	--

Shim

For placement beneath RivetRite posts. Has two 1/2" holes for anchoring. Unpainted, 14 gauge. Accepts anchors Cat.No. 9280 or 9281.

	3-1/2	2		46FPS00Z	2.30	Ea.	0.2	
---	-------	---	--	-----------------	-------------	-----	-----	--

Record Storage Box Supports

Used in place of particle board decking to support boxes and maintain neat organized storage. Supplied with nylon button fasteners.

	15			46BS15	4.95	Ea.	0.8	
	30			46BS30	7.50	Ea.	1.4	
	32			46BS32	10.05	Ea.	2.0	

Tie Plate

Used to join Angle Post units side by side to insure proper row alignment.

	3	3		46TP00C	1.45	Ea.	0.2	
---	---	---	--	----------------	-------------	-----	-----	--

W	D	H	*	Cat. No.	Price	Per	Wt.	Pkg.
---	---	---	---	----------	-------	-----	-----	------

Deck Over Grating Supports

3-1/2" h. - Provides secure support for grating when decking over entire installation. Can be used inside or outside upright posts to support decking. Capacity Per Support: 48" 3000, 60" 2500, 72" 2100.

	36			46GS36C	22.20	Ea.	8.8	
	42			46GS42C	25.45	Ea.	10.1	
	48			46GS48C	27.95	Ea.	11.7	
	60			46GS60C	34.25	Ea.	14.6	
	69			46GS69C	38.60	Ea.	16.7	
	72			46GS72C	40.15	Ea.	17.4	

Grating, Galvanized for RivetRite, 16 ga.

Use with Down Aisle Grating Supports. Interlocking grating has male and female flanges that interlock with adjacent planks for a continuous locked surface. Secure to Down Aisle Grating Supports with self tapping-screws. Order separately.

Non-Interlocking

	30	8-7/8	2	8GL030	39.85	Ea.	7.9	
	36	8-7/8	2	8GL036	43.15	Ea.	9.4	
	42	8-7/8	2	8GL042	49.60	Ea.	10.9	
	48	8-7/8	2	8GL048	54.60	Ea.	12.5	

Interlocking

	30	8-7/8	2	8AL030	21.30	Ea.	7.9	
	36	8-7/8	2	8AL036	25.40	Ea.	9.4	
	42	8-7/8	2	8AL042	29.70	Ea.	11.0	
	48	8-7/8	2	8AL048	33.95	Ea.	12.6	

Grating Fillers

3" w. - Galvanized. Special short length for use with RivetRite Down Aisle Grating Supports.

Galvanized

	30	3	2	8FK030	23.25	Ea.	4.1	
	36	3	2	8FK036	25.90	Ea.	5.0	
	42	3	2	8FK042	29.65	Ea.	5.8	
	48	3	2	8FK048	32.85	Ea.	6.6	

Grating and Grating filler are Galvanized so they require no paint



RivetRite Component Parts

W	D	H	*	Cat. No.	Price	Per	Wt.	Pkg.
---	---	---	---	----------	-------	-----	-----	------

W	D	H	*	Cat. No.	Price	Per	Wt.	Pkg.
---	---	---	---	----------	-------	-----	-----	------

Down Aisle Grating Supports

Attaches to unit front between rows to provide support for grating on 2-level RivetRite installations. For maximum aisle width of 48". Use a minimum of 3 screws per support. Capacity per Support: 48"-3000 lbs.; 60"-2500 lbs.; 72"-2100 lbs.

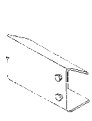

36	3-1/2	46DA36C	22.20	Ea.	8.8
48	3-1/2	46DA48C	27.95	Ea.	11.7
60	3-1/2	46DA60C	34.25	Ea.	14.6
69	3-1/2	46DA69C	38.60	Ea.	16.7
72	3-1/2	46DA72C	40.15	Ea.	17.4

Shelving & Main Aisle Support

To support decking across shelving or main aisle. Spacing between supports not to exceed 48" (formerly called 'Cross Aisle Support').



Includes Hardware to bolt to posts

30-1/2	3-1/2	46AX30H	23.75	Ea.	4.5
36-1/2	3-1/2	46AX36H	28.25	Ea.	5.5
42-1/2	3-1/2	46AX42H	32.70	Ea.	6.5
48-1/2	3-1/2	46AX48H	37.10	Ea.	9.5

Flue Spacing Components

To allow nominal 6" spacing between RivetRite Units to satisfy NFPA (Nat'l Fire Protection Agency) recommendations.

Use with RivetRite Posts

Can be used to join tee or angle post units back to back.

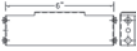

6	46RT06	5.30	Ea.	0.5
---	---------------	-------------	-----	-----

Use with RivetRite Posts, side by side.

6	46AX153	4.90	Ea.	0.4
---	----------------	-------------	-----	-----



Hanger Bars

1-1/4"w. x 1-1/4"h. - For hanging items between double rivet beams. One or more may be used per level.



36	46BH36C	8.85	Ea.	2.7
42	46BH42C	10.35	Ea.	3.1
48	46BH48C	11.55	Ea.	3.6
60	46BH60C	13.45	Ea.	4.4

Beam Cleat

An economical way to add on units. Not recommended for heavy loads.

(LH) Left Hand

3	3	46BC00C	2.65	Ea.	0.2
---	---	----------------	-------------	-----	-----

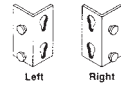

(RH) Right Hand

3	3	46BC01C	2.65	Ea.	0.2
---	---	----------------	-------------	-----	-----

Slotted Angle Cleat

For use where Heavy Duty Slotted Angle pieces must be joined, such as special grating supports and top ties

(LH) Left Hand

3	46SA00C	2.65	Ea.	0.2
---	----------------	-------------	-----	-----

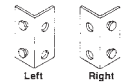

(RH) Right Hand

3	46SA01C	2.65	Ea.	0.2
---	----------------	-------------	-----	-----

Replacement Hardware

Four Wing Nuts and Four 10-24 x 5/8" TR HD Machine Screws required per Center Support.

Wing Nut For Center Support

8860	0.20	Ea.	0.1
-------------	-------------	-----	-----

TR HD Machine Screw, 10-24 x 5/8"

8704	0.10	Ea.	0.1
-------------	-------------	-----	-----

Particle Board Decking & Capacities



W	D	H *	Cat. No.	Price	Per	Wt.	Pkg.
---	---	-----	----------	-------	-----	-----	------

Particle Board Decking

Particle Board supplied by Penco is classified as 1-Medium Density-1 interior grade. If you are cutting your own board use nominal size & cut to +0" - 1/8".



NOTE: Check 5/8" Particle Board Capacity Table in the III. Price Book for the unit you require. Shelf deck capacity may not carry the rating of the steel framing.

36	12	94603	6.00	Ea.	6.6
36	15	94604	7.30	Ea.	8.2
36	18	94605	8.75	Ea.	10.0
36	24	94606	17.65	Ea.	13.0
36	30	94607	23.70	Ea.	16.5
36	36	94608	23.70	Ea.	19.8
42	12	94613	7.85	Ea.	7.7
42	15	94614	10.50	Ea.	9.6
42	18	94615	11.85	Ea.	11.5
42	24	94616	15.90	Ea.	15.4
42	30	94617	23.70	Ea.	19.2
42	36	94618	23.70	Ea.	23.0
48	12	94623	7.85	Ea.	8.8
48	18	94625	11.85	Ea.	13.2
48	24	94626	15.60	Ea.	18.0
48	30	94627	19.60	Ea.	22.0
48	36	94628	23.70	Ea.	26.3
48	48	94629	31.35	Ea.	35.0
60	18	94635	19.60	Ea.	16.5
60	24	94636	19.60	Ea.	22.0
60	30	94637	39.10	Ea.	27.4
60	36	94638	39.10	Ea.	32.9
60	48	94639	39.10	Ea.	43.8
69	15	94644	15.90	Ea.	15.8
69	30	94647	46.95	Ea.	31.5
72	18	94655	23.55	Ea.	19.7
72	24	94656	23.55	Ea.	26.3
72	30	94657	46.95	Ea.	32.9
72	36	94658	46.95	Ea.	39.4
72	48	94659	46.95	Ea.	52.6
96	18	94665	31.35	Ea.	26.3
96	24	94666	31.35	Ea.	35.0
96	30	94667	62.65	Ea.	43.8
96	36	94668	62.65	Ea.	52.6
96	48	94669	62.65	Ea.	70.0

Wire Deck is available for RivetRite as an alternative. Contact your Penco Representative for pricing on your requirements.

Particle Board Capacities

Recommended Safe Use Load Table For 5/8" Particle Board Allowable Uniformly Distributed Static Live Loads For Deck Material

Size (inches)	2 Sides Supported		4 Sides Supported		4 Sides + Center Support		4 Sides + 2 Center Supports	
	Load (lbs.)	Defl. (in.)	Load (lbs.)	Defl. (in.)	Load (lbs.)	Defl. (in.)	Load (lbs.)	Defl. (in.)
36 x 12	425	0.06	675	0.08				
36 x 18	400	0.17	550	0.18				
36 x 24	305	0.30	435	0.23				
36 x 30	250	0.47	385	0.32				
36 x 36	150	0.50	180	0.39				
42 x 12	490	0.06	755	0.08				
42 x 18	460	0.17	600	0.18				
42 x 24	355	0.30	500	0.29				
42 x 30	300	0.47	410	0.36				
42 x 36	175	0.50	385	0.45				
48 x 12	560	0.06	850	0.08	1160	0.08		
48 x 18	525	0.17	635	0.18	770	0.10		
48 x 24	405	0.30	530	0.30	700	0.11		
48 x 30	325	0.47	440	0.40	705	0.12		
48 x 36	200	0.50	400	0.50	755	0.12		
48 x 42	130	0.50	320	0.50	830	0.12		
48 x 48	85	0.50	275	0.50	920	0.13		
60 x 18	660	0.17	735	0.18	835	0.12	1140	0.08
60 x 24	505	0.30	615	0.32	700	0.15	1180	0.10
60 x 30	410	0.47	520	0.46	650	0.16	1324	0.11
60 x 36	250	0.50	380	0.50	665	0.17	1520	0.12
60 x 42	160	0.50	285	0.50	700	0.18	1750	0.13
60 x 48	105	0.50	230	0.50	750	0.18	2000	0.14
69 x 15	900	0.11	950	0.12	1150	0.12	1250	0.11
69 x 30	470	0.50	600	0.50	670	0.20	1220	0.13
72 x 18	800	0.17	850	0.17	1000	0.15	1200	0.10
72 x 24	605	0.30	680	0.31	770	0.19	1135	0.12
72 x 30	500	0.47	610	0.50	680	0.21	1200	0.14
72 x 36	300	0.50	390	0.50	655	0.23	1325	0.16
72 x 42	190	0.50	280	0.50	660	0.24	1500	0.17
72 x 48	130	0.50	215	0.50	685	0.25	1670	0.18
84 x 18	920	0.17	980	0.17	1200	0.17	1325	0.13
84 x 24	705	0.30	765	0.31	870	0.23	1150	0.15
84 x 30	570	0.47	650	0.49	735	0.27	1150	0.18
84 x 36	355	0.50	415	0.50	670	0.29	1210	0.20
84 x 42	225	0.50	290	0.50	750	0.32	1325	0.21
84 x 48	150	0.50	215	0.50	660	0.33	1460	0.23
96 x 18	1050	0.17	1115	0.17	1300	0.18	1500	0.15
96 x 24	810	0.30	850	0.31	1000	0.26	1200	0.18
96 x 30	655	0.47	710	0.48	800	0.32	1180	0.20
96 x 36	405	0.50	450	0.50	710	0.36	1150	0.24
96 x 42	255	0.50	300	0.50	670	0.39	1225	0.25
96 x 48	170	0.50	220	0.50	650	0.41	1325	0.28

NOTE: The above load chart refers to the Deck material only; 5/8" Particle Board type 1-M-1. The allowable shelf load capacity may be reduced due to allowable column and / or beam capacities. Specified allowable deflection limits may also reduce the shelf load capacity.

How to Select Pallet Rack Frames & Beams

Letters A through E refer to the diagram at right.

A. Height: Measure the height of the pallet and pallet load. Add an extra 4" to 6". Total is the required vertical clearance between beams or between floor and bottom of the first beam. (Beam spacing is in 3" increments.)

B. Depth: Measure the depth of the pallet. Pallet should overhang the beams by 3" to 4" front and back. (Example: for a 48" deep pallet use a 42" deep frame).

C. Width: Measure the width of the load and pallet, and use the greater of the two.

Add 3" to 4" between loads, and between loads and upright frames to determine correct beam length. Select beams with a capacity equal to or greater than the total load of each level.

D. Frame Capacity: Add the total of all loads for each bay (exclude the pallets on the floor), and review allowable upright frame loads based on the beam spacing (see chart below). Pick the appropriate capacity Upright in the size you need.

E. A common frame should be used between each of the sections.

Rack Upright Frame Configurations

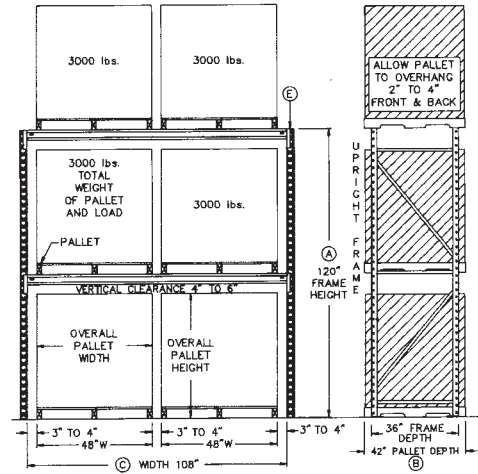
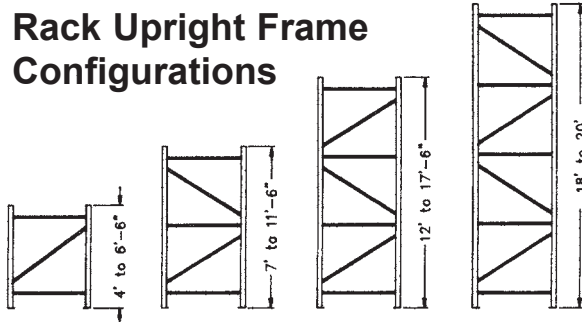

General Information

Anchoring: All pallet rack upright frames shall be anchored to the floor. Anchors are sold separately; see Pallet Rack Accessories.

Beam Capacities are shown per pair, in pounds. The capacity is calculated in compliance with RMI Specifications and AISI Standard. Calculations assume uniform load distribution. Beams of 138" and 144" span require a minimum of two (2) Heavy Duty Cross Bars.

'Traditional' Colors: Frames-028 Gray; Beams-710 Yellow; Accessories-028 Gray except for Frame Protectors (710 Yellow). Any of our standard colors can be ordered.

When ordering accessories, be sure to match the proper accessories with the beam step (either 7/8" or 1-5/8").

Frame Capacities Are calculated in compliance with Rack Manufacturer's Institute (RMI) Specifications and AISI Standard. Load data shown is for preliminary consideration only. Each installation must be individually evaluated for actual conditions and the use of each element in relation to the entire system with all aspects of the structural function. Frame capacities shown here are representative for most areas. In places where seismic activity is known to occur, we advise you to contact your Penco representative for assistance. You may want to order Pallet Rack PLUS instead (see box at right).

PALLET RACK UPRIGHT FRAME CAPACITY CHART

Allowable Upright load in Pounds

FRAME TYPE	Beam Spacing (Inches)											
	24	30	36	42	48	54	60	66	72	78	84	90
F	22,555	21,213	19,853	18,528	16,929	15,381	13,543	11,773	9,824	8,439	7,216	6,336
G	26,512	25,236	23,839	22,311	20,663	18,904	17,025	15,015	12,864	10,774	9,306	8,110
P	32,751	31,227	29,555	27,932	25,965	24,342	21,871	19,203	17,212	14,630	12,540	11,026
R	39,108	37,264	35,464	33,266	30,891	28,339	25,934	23,043	19,959	17,245	14,796	12,834
T	45,629	43,478	41,102	38,503	35,715	32,703	29,897	26,489	22,875	19,432	16,713	14,527

Pallet Rack PLUS

For Severe Conditions or High Seismic Activity

Pallet Rack Plus load capacities are the same as standard pallet rack shown in this price book, however the frames and beams are more resistant to horizontal and vertical forces that could damage standard rack and its load. To learn the seismic rating where your pallet rack will be in use, contact your Penco representative.

Beams: The Plus beams have 4 connectors

instead of 3 for a stronger connection between the beam and the upright post. The beam is welded 3" down from the top of the connector so loading is evenly distributed across all four connector prongs.

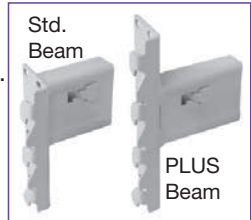

The beam locking key is the same as used on standard beams.

To Order PLUS BEAMS: ADD A "P" SUFFIX TO THE PART NUMBER, ADD \$25.00 TO THE PRICE/PAIR AND ADD 3 LBS TO THE WEIGHT per PAIR.

Upright Frames: Each Plus upright frame

has two 5" x 7" x 3/8" thick footplates with four 9/16" diameter anchoring holes. The extra holes provide the installer with more choices for floor anchoring.



To Order PLUS FRAMES: REPLACE THE 'C' PART NUMBER SUFFIX WITH A "PC" SUFFIX, ADD \$50.00 TO THE PRICE AND 6 LBS TO THE WEIGHT.

Other Options Penco also manufactures Double Posted Frames and Cantilever Leg Frames to RMI, ANSI and other custom requirements. Contact your Sales Representative for pricing.



Standard Pallet Rack Beams

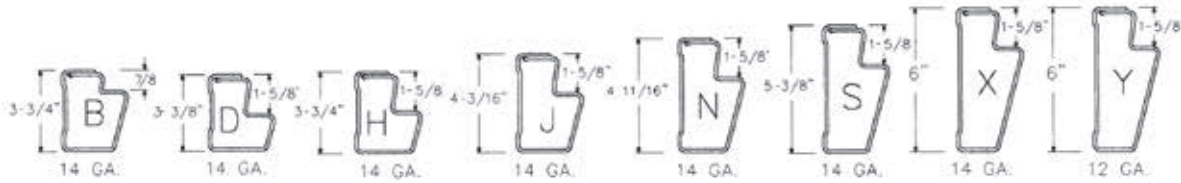

W	H	Capacity Lbs. **	Cat. No.	Price per Pair	Wt. Pair
---	---	------------------	----------	----------------	----------

Typical Beam Depth Dimensions

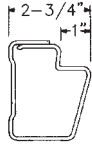

Pallet Rack Beams

48" Clear Span

W	H	Capacity Lbs. **	Cat. No.	Price per Pair	Wt. Pair
7/8" Step					
48	3-3/4	8920	5BB048	102.80	35.0
1-5/8" Step					
48	3-3/8	8380	5BD048	100.55	33.0
48	3-3/4	9430	5BH048	102.80	35.0
48	4-3/16	10670	5BJ048	106.15	36.0
48	4-11/16	12170	5BN048	111.55	38.0

54" Clear Span

W	H	Capacity Lbs. **	Cat. No.	Price per Pair	Wt. Pair
7/8" Step					
54	3-3/4	7920	5BB054	110.80	38.0
1-5/8" Step					
54	3-3/8	7445	5BD054	107.10	37.0
54	3-3/4	8370	5BH054	110.80	38.0
54	4-3/16	9480	5BJ054	114.60	40.0
54	4-11/16	10810	5BN054	120.20	42.0

60" Clear Span

W	H	Capacity Lbs. **	Cat. No.	Price per Pair	Wt. Pair
7/8" Step					
60	3-3/4	7120	5BB060	118.75	42.0
1-5/8" Step					
60	3-3/8	6695	5BD060	114.85	40.0
60	3-3/4	7530	5BH060	118.75	42.0
60	4-3/16	8520	5BJ060	123.10	44.0
60	4-11/16	9730	5BN060	128.65	46.0

66" Clear Span

W	H	Capacity Lbs. **	Cat. No.	Price per Pair	Wt. Pair
7/8" Step					
66	3-3/4	6470	5BB066	126.35	45.0
1-5/8" Step					
66	3-3/8	6080	5BD066	123.15	43.0
66	3-3/4	6840	5BH066	126.35	45.0
66	4-3/16	7740	5BJ066	130.95	47.0
66	4-11/16	8830	5BN066	137.30	50.0

72" Clear Span

W	H	Capacity Lbs. **	Cat. No.	Price per Pair	Wt. Pair
7/8" Step					
72	3-3/4	5920	5BB072	134.15	49.0
1-5/8" Step					
72	3-3/8	5570	5BD072	131.40	47.0
72	3-3/4	6260	5BH072	134.15	49.0
72	4-3/16	7090	5BJ072	139.20	51.0
72	4-11/16	8090	5BN072	146.05	54.0
72	5-3/8	9560	5BS072	154.50	57.0

W	H	Capacity Lbs. **	Cat. No.	Price per Pair	Wt. Pair
---	---	------------------	----------	----------------	----------

78" Clear Span

W	H	Capacity Lbs. **	Cat. No.	Price per Pair	Wt. Pair
7/8" Step					
78	3-3/4	5460	5BB078	142.20	52.0
1-5/8" Step					
78	3-3/8	5135	5BD078	139.75	50.0
78	3-3/4	5770	5BH078	142.20	52.0
78	4-3/16	6540	5BJ078	147.70	55.0
78	4-11/16	7460	5BN078	154.95	58.0
78	6	10220	5BX078	178.25	65.0

84" Clear Span

W	H	Capacity Lbs. **	Cat. No.	Price per Pair	Wt. Pair
7/8" Step					
84	3-3/4	5070	5BB084	149.85	56.0
1-5/8" Step					
84	3-3/8	4760	5BD084	147.60	53.0
84	3-3/4	5360	5BH084	149.85	56.0
84	4-3/16	6060	5BJ084	156.00	58.0
84	4-11/16	6920	5BN084	163.65	62.0
84	6	9480	5BX084	188.60	70.0
84	6	12650	5BY084	227.40	92.0

90" Clear Span

W	H	Capacity Lbs. **	Cat. No.	Price per Pair	Wt. Pair
7/8" Step					
90	3-3/4	4720	5BB090	157.60	59.0
1-5/8" Step					
90	3-3/8	4430	5BD090	154.95	57.0
90	3-3/4	4990	5BH090	157.60	59.0
90	4-3/16	5650	5BJ090	164.10	62.0
90	4-11/16	6450	5BN090	172.35	65.0
90	5-3/8	7630	5BS090	182.95	70.0
90	6	8840	5BX090	200.05	74.0
90	6	11800	5BY090	243.65	99.0

96" Clear Span

W	H	Capacity Lbs. **	Cat. No.	Price per Pair	Wt. Pair
7/8" Step					
96	3-3/4	4420	5BB096	165.25	63.0
1-5/8" Step					
96	3-3/8	3990	5BD096	162.55	60.0
96	3-3/4	4670	5BH096	165.25	63.0
96	4-3/16	5290	5BJ096	172.00	66.0
96	4-11/16	6040	5BN096	181.15	69.0
96	5-3/8	7190	5BS096	192.15	74.0
96	6	8280	5BX096	211.70	79.0
96	6	11050	5BY096	256.75	105.0

Traditional Color - 710 Sagebrush Yellow
 Clear Span = Inside Frame to Inside Frame Dimension
 ** Capacity per Pair for Uniformly Distributed Load
 Order by Catalog Number Only

Standard Pallet Rack Beams

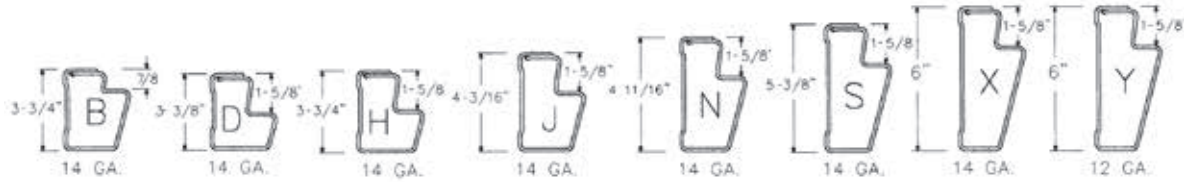

W	H	Capacity Lbs. **	Cat. No.	Price per Pair	Wt. Pair
102" Clear Span					
7/8" Step					
102	3-3/4	4160	5BB102	175.20	66.0
1-5/8" Step					
102	3-3/8	3530	5BD102	171.40	64.0
102	3-3/4	4390	5BH102	175.20	66.0
102	4-3/16	4980	5BJ102	182.35	70.0
102	4-11/16	5680	5BN102	192.00	73.0
102	5-3/8	6720	5BS102	203.70	79.0
102	6	7790	5BX102	222.35	83.0
102	6	10390	5BY102	274.00	111.0
108" Clear Span					
7/8" Step					
108	3-3/4	3920	5BB108	183.25	70.0
1-5/8" Step					
108	3-3/8	3150	5BD108	179.80	67.0
108	3-3/4	3990	5BH108	183.25	70.0
108	4-3/16	4690	5BJ108	191.00	73.0
108	4-11/16	5340	5BN108	200.95	77.0
108	5-3/8	6340	5BS108	213.40	83.0
108	6	7350	5BX108	233.85	88.0
108	6	9800	5BY108	287.75	117.0
114" Clear Span					
7/8" Step					
114	3-3/4	3540	5BB114	192.85	73.0
1-5/8" Step					
114	3-3/8	2830	5BD114	184.40	70.0
114	4-3/16	4440	5BJ114	201.10	77.0
114	6	6950	5BX114	244.60	92.0
114	6	9280	5BY114	301.60	123.0
120" Clear Span					
7/8" Step					
120	3-3/4	3190	5BB120	200.90	77.0
1-5/8" Step					
120	3-3/8	2550	5BD120	196.75	74.0
120	3-3/4	3230	5BH120	200.90	77.0
120	4-3/16	4130	5BJ120	209.55	81.0
120	4-11/16	4810	5BN120	220.75	85.0
120	5-3/8	5690	5BS120	234.55	91.0
120	6	6600	5BX120	256.40	97.0
120	6	8800	5BY120	315.20	129.0
126" Clear Span					
7/8" Step					
126	3-3/4	2900	5BB126	209.15	80.0
1-5/8" Step					
126	3-3/8	2310	5BD126	219.25	77.0
126	4-11/16	4570	5BN126	229.70	89.0
126	5-3/8	5410	5BS126	243.95	95.0
126	6	6270	5BX126	265.25	101.0
126	6	8370	5BY126	328.90	135.0

W	H	Capacity Lbs. **	Cat. No.	Price per Pair	Wt. Pair
132" Clear Span					
7/8" Step					
132	3-3/4	2840	5BB132	217.40	84.0
1-5/8" Step					
132	4-11/16	4410	5BN132	239.30	93.0
132	5-3/8	5160	5BS132	254.75	100.0
132	6	5980	5BX132	277.90	106.0
132	6	7980	5BY132	342.80	142.0
138" Clear Span					
7/8" Step					
138	3-3/4	2410	5BB138	225.75	87.0
1-5/8" Step					
138	4-11/16	4030	5BN138	248.25	97.0
138	6	5710	5BX138	287.65	110.0
138	6	7620	5BY138	356.45	148.0
144" Clear Span					
7/8" Step					
144	3-3/4	2220	5BB144	233.85	91.0
1-5/8" Step					
144	3-3/4	2240	5BH144	233.85	91.0
144	5-3/8	4740	5BS144	274.05	108.0
144	6	5500	5BX144	300.60	115.0
144	6	7340	5BY144	370.35	154.0

Traditional Color - 710 Sagebrush Yellow
 Clear Span = Inside Frame to Inside Frame Dimension
 ** Capacity per Pair for Uniformly Distributed Load
 Order by Catalog Number Only

W	D	H	*	Cat. No.	Price	Per	Wt.	Pkg.
---	---	---	---	----------	-------	-----	-----	------

W	D	H	*	Cat. No.	Price	Per	Wt.	Pkg.
---	---	---	---	----------	-------	-----	-----	------

General Duty Cross Bars, 16 Ga.

For 7/8" Step Beam

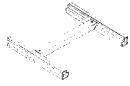

30	5AX530C	15.80	Ea.	3.6
36	5AX536C	17.75	Ea.	4.4
42	5AX542C	20.35	Ea.	5.3
48	5AX548C	23.15	Ea.	6.1
54	5AX554C	26.05	Ea.	6.8
60	5AX560C	28.40	Ea.	7.5

For 1-5/8" Step Beam



30	5AX630C	14.95	Ea.	3.6
36	5AX636C	17.25	Ea.	4.4
42	5AX642C	19.80	Ea.	5.3
48	5AX648C	22.20	Ea.	6.1
54	5AX654C	24.30	Ea.	6.8
60	5AX660C	27.20	Ea.	7.5

Heavy Duty Flanged Cross Bars, 16 Ga.

For 1-5/8" Step Beams



30	5AX730C	19.15	Ea.	4.5
36	5AX736C	20.95	Ea.	5.3
42	5AX742C	23.70	Ea.	6.1
48	5AX748C	26.40	Ea.	6.9
54	5AX754C	29.10	Ea.	7.7
60	5AX760C	32.10	Ea.	8.5

Plywood Supports, 16 Ga.

When used as a deck support (for plywood, particle board, etc.) we recommend that the center support be securely fastened (using Tek screw #8822) to both the front and rear beams. Plywood depth should be Frame depth minus 3-3/4".

For 7/8" Step Beam, 1/2" Deck



30	5AP230C	10.60	Ea.	3.6
36	5AP236C	12.50	Ea.	4.4
42	5AP242C	14.05	Ea.	5.3
48	5AP248C	15.80	Ea.	6.1

For 1-5/8" Step Beam, 3/4" Deck

30	5AP330	15.80	Ea.	3.6
36	5AP336	17.75	Ea.	4.4
42	5AP342	20.35	Ea.	5.3
48	5AP348	23.15	Ea.	6.1
54	5AP354	26.05	Ea.	6.8
60	5AP360	28.40	Ea.	7.5

Heavy Duty Skid Channels

11 Ga., 4" Wide Runners

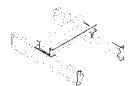

30	5AS230C	32.85	Ea.	9.3
36	5AS236C	36.70	Ea.	11.1
42	5AS242C	41.10	Ea.	12.9
48	5AS248C	45.20	Ea.	14.7

Fork Clearance Bars

11 Ga.

Raises unpalletized loads by 2-3/4".



30	5AF330C	30.15	Ea.	9.0
36	5AF336C	33.50	Ea.	10.7
42	5AF342C	37.60	Ea.	12.5
48	5AF348C	41.50	Ea.	14.2
54	5AF354C	45.60	Ea.	16.0
60	5AF360C	49.50	Ea.	17.7

Cross Bar Load Ratings For Offset Pallet Conditions

- For pallet depths equal to or greater than frame depth.
- NOT for uniformly distributed load conditions.
- For series 5AX500, 5AX600 and 5AX700.
- For rigid pallets only.

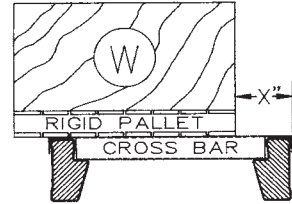

Frame Depth (inches)	Offset "X" (inches)	Max. Allowable Load "W" (lbs) on two Bars
36	4	6058
	5	3895
	6	2988
	7	2503
42	4	5960
	5	3786
	6	2868
	7	2370
48	4	5890
	5	3711
	6	2786
	7	2281
54	4	5838
	5	3655
	6	2727
	7	2217
60	4	5798
	5	3613
	6	2682
	7	2169

Coil Bed Assembly

7 Ga., Full Depth



30	5AC030C	70.45	Ea.	21.0
36	5AC036C	79.85	Ea.	25.0
42	5AC042C	90.15	Ea.	29.0
48	5AC048C	99.00	Ea.	33.0

Drum Wedges

Pairs

Attach to front beam only.



5AW000	9.30	Pr.	1.2
--------	------	-----	-----

Pallet Stop - Pairs

For 1-5/8" Step Beams Only

Attaches to rear beam with Tek screw # 8822 (included).



4	3-1/4	4	5AT00H	24.55	Pr.	5.4
---	-------	---	--------	-------	-----	-----

Self-Tapping screws are available for fastening accessories to beams. See Part No. 8822 in RivetRite Component Parts Section.

W	D	H	*	Cat. No.	Price	Per	Wt.	Pkg.
---	---	---	---	----------	-------	-----	-----	------

Rigid Row Spacers, 12 Ga.



Hardware Included								
6				5AR506	8.20	Ea.	2.0	
8				5AR508	9.30	Ea.	2.4	
10				5AR510	10.30	Ea.	2.8	
12				5AR512	11.15	Ea.	3.2	
18				5AR518	14.65	Ea.	4.5	
24				5AR524	17.65	Ea.	5.8	
30				5AR530	21.20	Ea.	6.7	
36				5AR536	24.30	Ea.	8.3	
42				5AR542	27.60	Ea.	9.6	
48				5AR548	30.25	Ea.	10.8	
54				5AR554	33.25	Ea.	12.1	
60				5AR560	36.15	Ea.	13.4	

Rigid Wall Spacers, 12 Ga.



Frame Hardware Included								
4				5AR404	6.45	Ea.	1.5	
6				5AR406	7.95	Ea.	2.0	
8				5AR408	8.85	Ea.	2.4	
10				5AR410	9.90	Ea.	2.8	
12				5AR412	10.80	Ea.	3.2	
18				5AR418	14.70	Ea.	4.6	

Reel Holder - Pairs

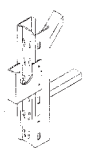

2-1/2" Diameter Max. Axle
Hardware Included. 1000 lb. capacity per pair maximum.

				5AH000	17.65	Pr.	3.0	
--	--	--	--	--------	-------	-----	-----	--

Frame Splice Channels - Pairs

Specify that top frame be manufactured without foot plates. Hardware included.



For Frame Type F, G & P								
				12 5AU008P	34.80	Pr.	4.5	
For Frame Type R & T								
				12 5AU018P	36.00	Pr.	6.0	

W	D	H	*	Cat. No.	Price	Per	Wt.	Pkg.
---	---	---	---	----------	-------	-----	-----	------

Frame Protector



Includes Frame Hardware
Floor Anchors Not Included.
Finished in 710 Yellow only. NOT for use with Pallet Rack PLUS upright frames.

				18 5AF018	30.15	Ea.	7.0	
--	--	--	--	-----------	-------	-----	-----	--

Frame Deflector

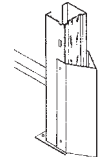

Finished 710 Yellow Only.

				18 5AF021PC	25.80	Ea.	5.8	
--	--	--	--	-------------	-------	-----	-----	--

Drum Rack Unit

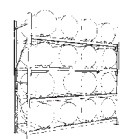

16-55 Gallon Drum Capacity
Consists of 4 pairs of "J" Beams, 2 "F" Uprights and 16 Coil Bed Assemblies.

				120 36 120 5SC0162312.10		Unit	664.0	
--	--	--	--	--------------------------	--	------	-------	--

Concrete Floor Anchor

1/2"-13 x 3-3/4"

				9580	3.60	Ea.	0.2	
--	--	--	--	------	------	-----	-----	--



Shim, 7 Ga.

Rack Foot Plate, Unpainted
Has 2-9/16" Holes

				3-1/4 4-1/4 55020	2.45	Ea.	0.8	
--	--	--	--	-------------------	------	-----	-----	--



Shim for Pallet Rack PLUS Foot Plate, 7 Ga.

Specify color.

				5 7 55021	6.35	Ea.	1.0	
--	--	--	--	-----------	------	-----	-----	--

W	D	H	*	Cat. No.	Price	Per	Wt.	Pkg.
---	---	---	---	----------	-------	-----	-----	------

W	D	H	*	Cat. No.	Price	Per	Wt.	Pkg.
---	---	---	---	----------	-------	-----	-----	------

Open, Fixed Height

All Fixed Height Bench models include two fixed height bench legs, one stringer, one bench top and all the necessary hardware for assembly.

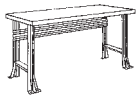
Steel Top								
	48	24	30	34300	353.90	Ea.	95.0	
	48	24	34	34310	367.10	Ea.	98.0	
	48	28	30	34320	359.15	Ea.	103.0	
	48	28	34	34330	371.85	Ea.	106.0	
	60	28	30	34420	407.00	Ea.	116.0	
	60	28	34	34430	419.65	Ea.	118.0	
	60	34	30	34460	432.90	Ea.	129.0	
	60	34	34	34470	445.65	Ea.	133.0	
	72	28	30	34520	446.35	Ea.	127.0	
	72	28	34	34530	459.10	Ea.	131.0	
	72	34	30	34560	473.65	Ea.	145.0	
	72	34	34	34570	486.25	Ea.	148.0	

Plastic Laminate Top - White Leather								
	60	28	29-7/8	34428	543.90	Ea.	133.0	
	60	28	33-7/8	34434	556.70	Ea.	136.0	
	60	34	29-7/8	34468	613.95	Ea.	155.0	
	60	34	33-7/8	34474	626.80	Ea.	158.0	
	72	28	29-7/8	34528	615.20	Ea.	152.0	
	72	28	33-7/8	34534	628.05	Ea.	154.0	
	72	34	29-7/8	34568	692.95	Ea.	199.0	
	72	34	33-7/8	34569	705.70	Ea.	201.0	

Tuff Top - Composition Core								
	48	24	30	34302	418.60	Ea.	111.0	
	48	24	34	34312	431.85	Ea.	113.0	
	48	28	30	34322	465.85	Ea.	124.0	
	48	28	34	34332	478.65	Ea.	127.0	
	60	28	30	34422	522.80	Ea.	145.0	
	60	28	34	34432	535.65	Ea.	147.0	
	60	34	30	34462	590.15	Ea.	168.0	
	60	34	34	34472	603.05	Ea.	170.0	
	72	28	30	34522	586.90	Ea.	162.0	
	72	28	34	34532	599.55	Ea.	164.0	
	72	34	30	34562	654.75	Ea.	188.0	
	72	34	34	34572	667.45	Ea.	190.0	

Butcher Block Wood Top								
	48	24	30	34303	576.05	Ea.	111.0	
	48	24	34	34313	589.20	Ea.	113.0	
	48	28	30	34323	636.50	Ea.	124.0	
	48	28	34	34333	649.50	Ea.	129.0	
	60	28	30	34423	727.80	Ea.	145.0	
	60	28	34	34433	740.50	Ea.	147.0	
	60	34	30	34463	854.65	Ea.	168.0	
	60	34	34	34473	867.40	Ea.	170.0	
	72	28	30	34523	855.25	Ea.	162.0	
	72	28	34	34533	868.00	Ea.	164.0	
	72	34	30	34563	997.40	Ea.	180.0	
	72	34	34	34573	1010.10	Ea.	182.0	

Open, Adjustable Height

All Adjustable Height Benches include two adjustable bench legs, one stringer, one bench top and all the necessary hardware for assembly. Height is adjustable in 1" increments.

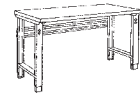
Steel Top								
Height Range 30" to 36"								
	48	28		34324	389.45	Ea.	99.0	
	60	28		34424	437.25	Ea.	112.0	
	60	34		34464	463.65	Ea.	119.0	
	72	28		34524	476.65	Ea.	125.0	
	72	34		34564	504.20	Ea.	149.0	

Plastic Laminate Top - White Leather								
Height Range 29-7/8" to 35-7/8"								
	60	28		34429	574.20	Ea.	129.0	
	60	34		34476	644.75	Ea.	145.0	
	72	28		34529	645.40	Ea.	154.0	
	72	34		34576	721.45	Ea.	189.0	

Tuff Top - Composition Core								
Height Range 30" to 36"								
	48	28		34326	495.95	Ea.	120.0	
	60	28		34426	553.25	Ea.	141.0	
	60	34		34466	620.80	Ea.	158.0	
	72	28		34526	621.50	Ea.	158.0	
	72	34		34566	685.50	Ea.	178.0	

Butcher Block Wood Top								
	48	28		34327	666.90	Ea.	120.0	
	60	28		34427	758.10	Ea.	141.0	
	60	34		34467	885.30	Ea.	158.0	
	72	28		34527	885.55	Ea.	158.0	
	72	34		34567	1028.00	Ea.	178.0	

Open, Fixed Height-with Shelf

All Fixed Height Bench models include two fixed height legs, one stringer, one bench top, one bench shelf and all the necessary hardware for assembly.

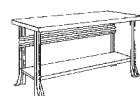
Steel Top								
	48	24	30	30300	414.00	Ea.	107.0	
	48	24	34	30310	427.30	Ea.	110.0	
	48	28	30	30320	419.25	Ea.	115.0	
	48	28	34	30330	432.00	Ea.	118.0	
	60	28	30	30420	475.15	Ea.	131.0	
	60	28	34	30430	488.00	Ea.	133.0	
	60	34	30	30460	501.20	Ea.	144.0	
	60	34	34	30470	513.85	Ea.	148.0	
	72	28	30	30520	520.15	Ea.	145.0	
	72	28	34	30530	532.95	Ea.	149.0	
	72	34	30	30560	547.35	Ea.	163.0	
	72	34	34	30570	560.15	Ea.	166.0	

Plastic Laminate Top - White Leather								
	60	28	29-7/8	30428	612.15	Ea.	148.0	
	60	28	33-7/8	30434	624.95	Ea.	151.0	
	60	34	29-7/8	30468	682.20	Ea.	170.0	
	60	34	33-7/8	30474	695.15	Ea.	173.0	
	72	28	29-7/8	30528	684.75	Ea.	170.0	
	72	28	33-7/8	30534	701.80	Ea.	172.0	
	72	34	29-7/8	30568	766.75	Ea.	217.0	
	72	34	33-7/8	30569	779.70	Ea.	219.0	

Open Work & Modular Work Benches



W	D	H *	Cat. No.	Price	Per	Wt.	Pkg.
---	---	-----	----------	-------	-----	-----	------

Tuff Top - Composition Core

48	24	30	30302	478.80	Ea.	123.0	
48	24	34	30312	492.05	Ea.	125.0	
48	28	30	30322	525.95	Ea.	136.0	
48	28	34	30332	538.75	Ea.	139.0	
60	28	30	30422	591.05	Ea.	160.0	
60	28	34	30432	603.80	Ea.	162.0	
60	34	30	30462	658.45	Ea.	183.0	
60	34	34	30472	671.10	Ea.	185.0	
72	28	30	30522	660.75	Ea.	180.0	
72	28	34	30532	673.60	Ea.	182.0	
72	34	30	30562	728.50	Ea.	206.0	
72	34	34	30572	741.35	Ea.	208.0	

Butcher Block Wood Top

48	24	30	30303	636.20	Ea.	123.0	
48	24	34	30313	649.50	Ea.	125.0	
48	28	30	30323	696.90	Ea.	136.0	
48	28	34	30333	709.75	Ea.	141.0	
60	28	30	30423	796.05	Ea.	160.0	
60	28	34	30433	808.80	Ea.	162.0	
60	34	30	30463	922.90	Ea.	183.0	
60	34	34	30473	935.65	Ea.	185.0	
72	28	30	30523	931.25	Ea.	180.0	
72	28	34	30533	944.10	Ea.	182.0	
72	34	30	30563	1071.25	Ea.	198.0	
72	34	34	30573	1083.90	Ea.	200.0	

Open, Adjustable Height-with Shelf

All Adjustable Height Benches include two adjustable bench legs, one stringer, one bench top, one bench shelf and all the necessary hardware for assembly. Height is adjustable in 1" increments.

Steel Top		Height Range 30" to 36"			
48	28	30324	449.55	Ea.	111.0
60	28	30424	505.55	Ea.	127.0
60	34	30464	531.80	Ea.	134.0
72	28	30524	550.45	Ea.	143.0
72	34	30564	578.15	Ea.	167.0

Plastic Laminate Top - White Leather

Plastic Laminate Top - White Leather		Height Range 29-7/8" to 35-7/8"			
60	28	30429	642.35	Ea.	144.0
60	34	30476	712.85	Ea.	160.0
72	28	30529	719.25	Ea.	172.0
72	34	30576	795.30	Ea.	207.0

Tuff Top - Composition Core

Tuff Top - Composition Core		Height Range 30" to 36"			
48	28	30326	556.15	Ea.	132.0
60	28	30426	621.30	Ea.	156.0
60	34	30466	689.10	Ea.	173.0
72	28	30526	691.05	Ea.	176.0
72	34	30566	759.25	Ea.	196.0

Butcher Block Wood Top

48	28	30327	727.15	Ea.	132.0
60	28	30427	826.20	Ea.	156.0
60	34	30467	953.60	Ea.	173.0
72	28	30527	961.55	Ea.	176.0
72	34	30567	1101.90	Ea.	196.0

W	D	H *	Cat. No.	Price	Per	Wt.	Pkg.
---	---	-----	----------	-------	-----	-----	------

Modular Benches, 4 Drawers, 1 Cabinet

Drawer and Cabinet pedestals have bases included. When building Modular Benches from component parts, remember to order the correct height base for your pedestals.

Steel Top					
60	28	30	32090 1251.80	Ea.	198.0
60	28	34	32095 1283.80	Ea.	206.0
72	28	30	32110 1287.65	Ea.	208.0
72	28	34	32115 1319.65	Ea.	217.0

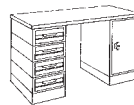

Plastic Laminate Top - White Leather

60	28	29-7/8	32094 1388.80	Ea.	216.0
60	28	33-7/8	32099 1420.80	Ea.	224.0
72	28	29-7/8	32114 1456.45	Ea.	221.0
72	28	33-7/8	32119 1488.40	Ea.	230.0

Tuff Top - Composition Core

60	28	30	32093 1367.75	Ea.	222.0
60	28	34	32098 1399.70	Ea.	230.0
72	28	30	32113 1428.05	Ea.	236.0
72	28	34	32118 1460.20	Ea.	245.0

Butcher Block Wood Top

60	28	30	32092 1572.75	Ea.	222.0
60	28	34	32097 1604.70	Ea.	230.0
72	28	30	32112 1698.70	Ea.	236.0
72	28	34	32117 1730.75	Ea.	245.0

Modular Benches, 8 Drawers

Steel Top					
60	28	30	32050 1491.60	Ea.	241.0
60	28	34	32055 1523.75	Ea.	249.0
72	28	30	32070 1527.55	Ea.	252.0
72	28	34	32075 1559.45	Ea.	260.0



Plastic Laminate Top - White Leather

60	28	29-7/8	32054 1628.50	Ea.	259.0
60	28	33-7/8	32059 1660.70	Ea.	267.0
72	28	29-7/8	32074 1696.20	Ea.	264.0
72	28	33-7/8	32079 1728.25	Ea.	273.0

Tuff Top - Composition Core

60	28	30	32053 1607.55	Ea.	265.0
60	28	34	32058 1639.45	Ea.	273.0
72	28	30	32073 1667.90	Ea.	279.0
72	28	34	32078 1699.90	Ea.	288.0

Butcher Block Wood Top

60	28	30	32052 1812.55	Ea.	265.0
60	28	34	32057 1844.50	Ea.	273.0
72	28	30	32072 1938.50	Ea.	279.0
72	28	34	32077 1970.55	Ea.	288.0



Modular Benches, Shop Desks & Bench Components

W	D	H	*	Cat. No.	Price	Per	Wt.	Pkg.
---	---	---	---	----------	-------	-----	-----	------

W	D	H	*	Cat. No.	Price	Per	Wt.	Pkg.
---	---	---	---	----------	-------	-----	-----	------

Modular Benches, 2 Cabinets

Steel Top

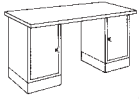

60	28	30		32010 1012.05	Ea.	155.0		
60	28	34		32015 1043.95	Ea.	163.0		
72	28	30		32030 1047.75	Ea.	165.0		
72	28	34		32035 1079.80	Ea.	174.0		

Plastic Laminate Top - White Leather

60	28	29-7/8		32014 1148.95	Ea.	172.0		
60	28	33-7/8		32019 1181.00	Ea.	181.0		
72	28	29-7/8		32034 1216.60	Ea.	178.0		
72	28	33-7/8		32039 1248.60	Ea.	187.0		

Tuff Top - Composition Core

60	28	30		32013 1127.95	Ea.	178.0		
60	28	34		32018 1159.80	Ea.	187.0		
72	28	30		32033 1188.30	Ea.	193.0		
72	28	34		32038 1220.20	Ea.	202.0		

Butcher Block Wood Top

60	28	30		32012 1332.90	Ea.	178.0		
60	28	34		32017 1364.85	Ea.	187.0		
72	28	30		32032 1458.85	Ea.	193.0		
72	28	34		32037 1490.95	Ea.	202.0		

Shop Desk

Legs adjust for 41" or 43-1/2" work surface height. Welded riser assembly bolts on and adds 7" to overall height. Includes lock and 2 keys.

Open Type



34	30	43-1/2		35100C	419.10	Ea.	75.0	1
----	----	--------	--	---------------	--------	-----	------	---

Cabinet Pedestal

For Modular Benches

Cabinet may be inverted for left or right hand hinged door. Ships welded set-up with shelf. Includes lock and two keys.

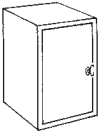

15-3/4	20	27		32505	340.90	Ea.	41.0	
--------	----	----	--	--------------	--------	-----	------	--

Cabinet Bases

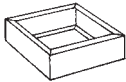

15-3/4	20	1-1/4		32170	51.60	Ea.	3.0	
15-3/4	20	5-1/4		32171	67.65	Ea.	7.0	

Fixed Height Bench Legs

For Open Bench Construction

Can be anchored to floor.

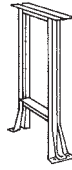

24	28-1/4	31075	69.05	Ea.	14.0
24	32-1/4	31077	75.65	Ea.	15.0
28	28-1/4	31080	71.40	Ea.	16.0
28	32-1/4	31082	77.75	Ea.	16.0
34	28-1/4	31090	74.00	Ea.	18.0
34	32-1/4	31092	80.20	Ea.	19.0

Adjustable Height Bench Legs

28-1/4" to 34-1/4" High

Height is adjustable on 1" increments. Can be anchored to floor.

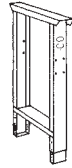

28		31093H	86.50	Ea.	12.0
34		31097H	89.20	Ea.	13.0

Stringers

Provides Lateral Stability



48	5	31135H	34.55	Ea.	6.0
60	5	31136H	37.30	Ea.	8.0
72	5	31137H	40.90	Ea.	9.0

Bench Shelves

For Open Benches



48	12	31110H	60.30	Ea.	12.0
60	12	31115H	68.25	Ea.	15.0
72	12	31120H	73.90	Ea.	18.0

Back and End Stops

Fits On All Penco Bench Tops

Hardware included for assembly and attaching to steel tops. Hardware for attaching to plastic laminate, wood or composition tops requires Mounting Kit Cat. No. 31223.



48	24	30971	75.20	Ea.	8.4
48	28	30976	76.30	Ea.	9.0
60	28	30977	76.25	Ea.	10.0
60	34	30987	80.10	Ea.	10.9
72	28	30978	76.70	Ea.	11.0
72	34	30988	80.45	Ea.	11.8

W	D	H	*	Cat. No.	Price	Per	Wt.	Pkg.
---	---	---	---	----------	-------	-----	-----	------

W	D	H	*	Cat. No.	Price	Per	Wt.	Pkg.
---	---	---	---	----------	-------	-----	-----	------

Risers



Hardware included for assembly and attaching to steel tops. Hardware for attaching to wood, plastic laminate or composition tops requires Mounting Kit Cat. No. 31223.

48	10	12		30965	125.95	Ea.	18.4	
60	10	12		30966	134.60	Ea.	21.6	
72	10	12		30967	141.25	Ea.	24.4	

Electrical Outlet Strip

Finish: Ivory only. Mounting hardware not included. Requires installation by a qualified electrician.

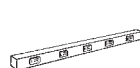

5 Outlets

60				9371	100.30	Ea.	3.0	
----	--	--	--	-------------	---------------	-----	-----	--

6 Outlets

72				9372	112.90	Ea.	4.0	
----	--	--	--	-------------	---------------	-----	-----	--

Case and Drawers

With Sliding Tray

Hardware for bolting together stacked is included. Locks not included. Padlocks may also be used. Mounting Kit Cat. No. 31223 required for mounting to wood or composition tops. For mounting to steel tops, order Drawer Mounting Channels below.

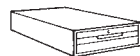

15-3/4	20	6-3/4		30960	145.00	Ea.	20.0	
21-3/4	20	6-3/4		30962	155.45	Ea.	25.0	

Drawer Mounting Channels (for Steel tops)



Also used to attach Cabinet Pedestals and pedestals built from drawers to steel tops on Modular Benches. Order two (2) each per pedestal or drawer.

24				31140	7.35	Ea.	2.6	
28				31141	7.60	Ea.	3.0	
34				31143	8.50	Ea.	3.6	

Steel Bench Tops, 1-3/4" Thick



Two end channels provided with each top.

48	24			31145	181.20	Ea.	44.0	
48	28			31151	181.70	Ea.	51.0	
60	28			31152	226.95	Ea.	62.0	
60	34			31161	248.05	Ea.	75.0	
72	28			31153	262.80	Ea.	72.0	
72	34			31162	284.85	Ea.	85.0	

Plastic Laminate Tops, 1-5/8" Thick

Top surface and edges are covered in attractive "White Leather" plastic laminate bonded to a high density particle board.

60	28			9366H	361.85	Ea.	82.0	
60	34			9368H	426.75	Ea.	100.0	
72	28			9367H	429.25	Ea.	100.0	

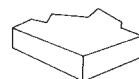

Top surface and edges are covered in attractive "White Leather" plastic laminate bonded to a high density particle board.

72	34			9369H	502.00	Ea.	120.0	
----	----	--	--	--------------	---------------	-----	-------	--

Tuff Tops, 1-3/4" Thick

Hard resin board surface bonded to a composition core with hardboard rails. Radiused top front edge.

48	24			9355H	243.65	Ea.	63.0	
48	28			9358H	286.15	Ea.	72.0	
60	28			9359H	340.80	Ea.	88.0	
60	34			9362H	403.10	Ea.	115.0	
72	28			9360H	401.10	Ea.	115.0	
72	34			9363H	463.70	Ea.	134.0	



Butcher Block Wood Tops, 1-3/4" Thick

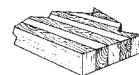

Seasoned kiln dried hardwood provides an extremely durable, attractive and long lasting top surface.

48	24			9341H	401.10	Ea.	59.0	
48	28			9344H	457.15	Ea.	70.0	
60	28			9345H	545.65	Ea.	88.0	
60	34			9348H	667.35	Ea.	107.0	
72	28			9346H	671.70	Ea.	103.0	
72	34			9349H	806.35	Ea.	130.0	

Bench Accessory Hardware Kit For Back and End Stops and Risers

Kit Includes: 8 - 08300 Hex Lag Screws 1/4" x 1-1/4". For use with wood, plastic laminate or composition tops.

31223	2.35	Ea.	0.3
--------------	-------------	-----	-----



Inventory Carts & Service Carts

W	D	H	*	Cat. No.	Price	Per	Wt.	Pkg.
---	---	---	---	----------	-------	-----	-----	------

W	D	H	*	Cat. No.	Price	Per	Wt.	Pkg.
---	---	---	---	----------	-------	-----	-----	------

Inventory Carts-723 Lt. Putty

48" High - 3 Levels

With Particle Board Deck

36	24	48		35076P	300.35	Ea.	94.0	
48	24	48		35077P	334.20	Ea.	116.0	
60	24	48		35078P	371.95	Ea.	139.0	

With White Melamine Deck

36	24	48		35080P	323.40	Ea.	94.0	
48	24	48		35081P	359.55	Ea.	116.0	
60	24	48		35082P	385.20	Ea.	139.0	

NO Deck

36	24	48		35095P	254.90	Ea.	49.0	
48	24	48		35096P	294.05	Ea.	56.0	
60	24	48		35097P	321.75	Ea.	64.0	

60" High - 4 Levels

With Particle Board Deck

36	24	60		35074P	337.80	Ea.	117.0	
48	24	60		35073P	377.85	Ea.	145.0	
60	24	60		35075P	412.30	Ea.	181.0	

With White Melamine Deck

36	24	60		35083P	357.30	Ea.	117.0	
48	24	60		35084P	393.75	Ea.	145.0	
60	24	60		35085P	424.50	Ea.	181.0	

NO Deck

36	24	60		35092P	277.25	Ea.	57.0	
48	24	60		35093P	324.30	Ea.	65.0	
60	24	60		35094P	345.50	Ea.	81.0	

Inventory Cart Components

Shelf Level Kit

4 Beams & 1 Pc. Particle Board

36	24			35086P	32.95	Kit	19.0	
48	24			35087P	32.50	Kit	25.0	
60	24			35088P	52.45	Kit	37.0	

4 Beams & 1 Pc. Melamine

36	24			35089P	45.50	Kit	19.0	
48	24			35090P	54.25	Kit	25.0	
60	24			35091P	78.05	Kit	37.0	

Deck Only

Particle Board Deck

36	24			94606	15.15	Ea.	13.0	
48	24			94626	13.35	Ea.	18.0	
60	24			94636	16.80	Ea.	22.0	

White Melamine Deck

36	24			94706	27.70	Ea.	13.0	
48	24			94726	35.10	Ea.	18.0	
60	24			94736	42.35	Ea.	22.0	

For components of extra shelf levels for Inventory Carts, see the RivetRite Component Parts section.

For 36" & 48" long carts (Single Rivet Beams):

24", **46SS24P** 36", **46SS36P** 48", **46SS48P**

For 60" long carts (Double Rivet Beams)

24", **46SB24P** 60", **46HB60P**

Service Carts

Basic 2 Tray

16	30	32		33000	281.65	Ea.	51.0	
24	36	32		33001	322.30	Ea.	69.0	

1 Drawer

1 Drawer 15-3/4" wide.

24	36	32		33014	467.50	Ea.	116.0	
1 Drawer 21-3/4" wide.								
24	36	32		33018	477.90	Ea.	121.0	

2 Drawers

2 Drawers 15-3/4" wide.

24	36	32		33015	612.65	Ea.	137.0	
2 Drawers 21-3/4" wide.								
24	36	32		33019	633.45	Ea.	147.0	

2 Drawers and Center Tray

2 Drawers 15-3/4" wide, 1 Center Tray.

24	36	32		33016	701.60	Ea.	163.0	
2 Drawers 21-3/4" wide, 1 Center Tray								
24	36	32		33020	722.35	Ea.	173.0	

3 Drawers

3 Drawers 15-3/4" wide.

24	36	32		33017	757.70	Ea.	158.0	
3 Drawers 21-3/4" wide.								
24	36	32		33021	789.00	Ea.	173.0	

Service Cart Trays

3" Deep

16	30			33010H	67.75	Ea.	18.0	
24	36			33011H	88.95	Ea.	26.0	

5" Replacement Caster For Service Carts

2 Rigid, 2 Swivel

125# Capacity Per Caster

				9375	78.30	Set	8.0	
--	--	--	--	-------------	--------------	-----	-----	--

W	D	H	*	Cat. No.	Price	Per	Wt.	Pkg.
---	---	---	---	----------	-------	-----	-----	------

Stool With Masonite Seat (Gray)

ORDER IN MULTIPLES OF TWO ONLY. 14" diameter steel seat covered with hardboard.



18" To 26" Height Adjustment		24" To 32" Height Adjustment	
18-26	9317 98.30	Ea.	11.0 2
24-32	9316 153.90	Ea.	12.0 2

Stool Backrest

Order in multiples of TWO only.

9336	76.55	Ea.	6.0 2
------	-------	-----	-------



Stool Cushion, Upholstered

Backrest Cushion

9314	32.75	Ea.	0.5
------	-------	-----	-----

Seat Cushion

9315	43.70	Ea.	1.0
------	-------	-----	-----



Cylinder Cam Lock

For use with work bench drawer or as a replacement on shop desk. For keyed alike group sets, consult your Penco Representative.

Keyed Differently

9389	18.05	Ea.	0.2
------	-------	-----	-----

Master Key

93891	5.10	Ea.	0.1
-------	------	-----	-----

Keyed Alike

9390	22.85	Ea.	0.2
------	-------	-----	-----



Padlock Clip

Used as a replacement part for Case and Drawer and Shop Desk drawers.

31212Z	3.60	Ea.	0.3
--------	------	-----	-----

T-Handle Lock Assembly

Used as replacement parts for cabinets with TEE Handles.

Keyed Differently

8797	24.70	Ea.	2.0
------	-------	-----	-----

Master Key

93891	5.10	Ea.	0.1
-------	------	-----	-----



Storage Cabinets w/Recessed Handle

Four full width shelves adjustable on 2" centers. Recessed handle with 2 keys; 3 point latching.

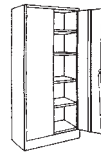

Knocked Down

36	18	78	76218	611.70	Ea.	131.0
36	21	78	76221	630.95	Ea.	147.0
36	24	78	76224	692.25	Ea.	155.0

Assembled

36	18	78	76218A	856.40	Ea.	131.0
36	21	78	76221A	883.25	Ea.	147.0
36	24	78	76224A	969.10	Ea.	155.0

Wardrobe Cabinets w/Recessed Handle

Spacious cabinet with full width top shelf and coat rod that will accommodate up to 15 coats.

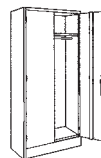

Knocked Down

36	18	78	76318	594.45	Ea.	119.0
36	21	78	76321	613.65	Ea.	125.0
36	24	78	76324	669.30	Ea.	131.0

Assembled

36	18	78	76318A	832.20	Ea.	119.0
36	21	78	76321A	859.15	Ea.	125.0
36	24	78	76324A	937.00	Ea.	131.0

Combination Cabinets w/Recessed Handle

Clothing hangs on one side, supplies on the other. Four half shelves adjust on 6" centers. Full width shelf at top.



Knocked Down

36	18	78	76418	712.10	Ea.	148.0
36	21	78	76421	735.80	Ea.	158.0
36	24	78	76424	804.70	Ea.	168.0

Assembled

36	18	78	76418A	996.95	Ea.	148.0
36	21	78	76421A	1030.10	Ea.	158.0
36	24	78	76424A	1126.50	Ea.	168.0

Storage Cabinets w/"L" Handle

Features heavy duty top for counter height use and two full width adjustable shelves. Locking "L" handle with 2 keys; three point latch.

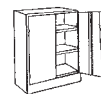

42" High - Knocked Down

36	18	42	75018	565.75	Ea.	78.0
36	24	42	75024	599.35	Ea.	92.0
48	24	42	75124	928.45	Ea.	124.0

48" Wide x 78" High - Knocked Down

Spacious 48" wide cabinet with four adjustable full width shelves. Locking "L" handle with 2 keys; three point latching. Ships in 2 cartons.

48	24	78	76715	1054.65	Ea.	203.0
----	----	----	-------	---------	-----	-------



Combination Conversion Kit

For 36"w x 78"h only.

For converting a storage or wardrobe cabinet into a combination cabinet.

18	76518	117.70	Ea.	28.0
21	76521	122.20	Ea.	32.0
24	76524	135.30	Ea.	36.0



E-Z Bilt™ Storage Cabinets Parts / Touchup Paint

W	D	H	*	Cat. No.	Price	Per	Wt.	Pkg.
---	---	---	---	----------	-------	-----	-----	------

W	D	H	*	Cat. No.	Price	Per	Wt.	Pkg.
---	---	---	---	----------	-------	-----	-----	------

Extra Full Width Shelves

For conversion of a basic wardrobe cabinet into a storage cabinet or for adding additional shelves to a storage cabinet. Clips not required.

For Storage Cabinets

36	18	766571C	28.90	Ea.	6.5
36	21	766572C	32.10	Ea.	7.5
36	24	766573C	35.65	Ea.	8.5
48	24	766568C	86.25	Ea.	17.0

Extra Half Shelves

For adding additional half shelves to the Combination Cabinet. For 36" w x 78" h only. Order two shelf clips per shelf Cat. No. 76064.

For Combination Cabinets

18	18	766574C	24.40	Ea.	3.0
18	21	766575C	25.55	Ea.	3.5
18	24	766576C	26.60	Ea.	4.0

Half Shelf Clip

76064	1.60	Ea.	0.6
-------	------	-----	-----

Replacement Parts

Recessed Handle/Lock Assembly

For 36" w x 78" High Cabinets

9760	21.20	Ea.	1.5
------	-------	-----	-----



Recessed Handle Master Key

97601	6.00	Ea.	0.1
-------	------	-----	-----

Recessed Handle Blank Key

97602	3.50	Ea.	0.1
-------	------	-----	-----

"L" Handle

For 42" High & 48" Wide Cabinets

8799	21.20	Ea.	2.0
------	-------	-----	-----



"L" Handle Master Key

93891	5.10	Ea.	0.1
-------	------	-----	-----

Coat Rod

For 36" Wide Cabinets

36	8793H	6.65	Ea.	3.0
----	-------	------	-----	-----

Touch Up Paint, Air Dry

4.5 Oz. Spray Can, Air Dry



1.0	Tawny Tan	97012	25.60	Ea.	
	1.0	Gray Ash	97021	25.60	Ea. 1.0
		028 Gray	97028	25.60	Ea. 1.0
		Reflex Blue	97052	25.60	Ea.
	Canvas	97054	25.60	Ea.	1.0
	Shamrock	97055	25.60	Ea.	1.0
	Sunburst	97056	25.60	Ea.	1.0
1.0	Nordic Purple	97058	25.60	Ea.	
1.0	Champagne	97073	25.60	Ea.	
1.0	Spray Green	97701	25.60	Ea.	
1.0	Sagebrush Yellow	97710	25.60	Ea.	
1.0	Lake Blue	97715	25.60	Ea.	1.0
	Mandarin Orange	97720	25.60	Ea.	
1.0	Patriot Red	97722	25.60	Ea.	1.0
	Light Putty	97723	25.60	Ea.	1.0
	Burgundy	97736	25.60	Ea.	1.0
1.0	Cardinal Red	97767	25.60	Ea.	
1.0	Marine Blue	97806	25.60	Ea.	
1.0	Hunter Green	97812	25.60	Ea.	
1.0	Regal Blue	97822	25.60	Ea.	1.0
	Slate Blue	97826	25.60	Ea.	1.0
	January	97848	25.60	Ea.	1.0
	Jet Black	97949	25.60	Ea.	1.0
	Turquoise Teal	97952	25.60	Ea.	

Gallon Cans

GALLON	206.10	Ea.	10.0
--------	--------	-----	------

Illustrated Price Book
For Shelving, Shelving Accessories, Pallet Rack,
Shop Furniture and Storage Cabinets

See our other price lists for *Lockers*,
Erectomatic® Shelving & QuickShip products.

All prices shown are FOB plant of manufacture, with standard construction, unless otherwise stated.
Prices and specifications are subject to change without notice.

Main Office

Penco Products, Inc.
1820 Stonehenge Drive
Greenville, NC 27858

Phone: 800-562-1000
252-917-5287

Fax: 800-248-1555
252-917-5294

*Send orders directly to the
main office.*

Manufacturing

1301 Penco Drive
Hamilton, NC 27840

 *Advantage!*  Contract Holder

Trade Associations



QuickShip Distribution Centers*
Northeast

Pennsylvania QuickShip
524 Imperial Court, Suite D
Bensalem, PA 19020

South

Tennessee QuickShip
3624 Democrat Road
Suite 2
Memphis, TN 38118

Central

Indiana QuickShip
2602 Innovation Court
Fort Wayne, IN 46818

West

Utah QuickShip
4080 West Farm Road
Salt Lake City, UT 84088

* QuickShip lockers and other QuickShip products are in a separate price list. To see which products are stocked at each Penco warehouse location, go to www.pencoproducts.com/quickship



Every customer's first choice to transform space into safe, secure and effective storage.